

Pearl[®]

MARCHING & CONCERT



Pearl®

PEARL MARCHING & CONCERT 2017

- 4 - 5 A Standard of Excellence
- 6 - 7 The Pearl Difference

MARCHING PERCUSSION

- 8 Championship Black Out
- 9 Varsity Wrap Series
- 10 - 11 Championship CarbonCore
- 12 - 15 Championship Maple
- 16 - 19 Competitor Series
- 20 - 21 Junior Marching Series
- 22 - 25 Championship Pipe
- 26 - 27 CX AirFrame Carriers
- 28 - 29 MX T-Frame Carriers
- 30 - 31 Advanced Marching Hardware
- 32 - 33 Accessories

CONCERT PERCUSSION

- 34 - 37 Philharmonic Series Drums
- 38 - 39 Symphonic Series Drums
- 40 - 41 Concert Series Drums
- 42 - 45 Educational Kits
- 46 - 49 Advanced Concert Hardware

ACCESSORIES & SETS

- 50 - 51 Congas, Bongos, Cajons, Timbales
- 52 - 53 Concert Accessories
- 54 - 55 Drum Sets
- 56 Color Chart



For more info, please visit any of our sites listed below:



HALL OF CHAMPIONS
Join the excitement of gameday and experience the **Sound of Saturday!** Featuring collegiate athletic bands from across the country who choose Pearl / Adams for their percussion needs.

www.PearlHallOfChampions.com



PEARL RUDIMENTS
Learn the 40 PAS Sanctioned Rudiments with **over 100+ videos** from Legendary Pearl Artists such as Thom Hannum, Mike Mangini, and Grant Collins.

www.PearlDrumRudiments.com



PEARL / ADAMS DCI
Complete coverage throughout the Drum Corps International season of your favorite Pearl / Adams drum corps. Photo galleries, lot videos, and more!

www.PearlAdamsDCI.com



PEARL / ADAMS WGI
Featuring coverage of your favorite Pearl / Adams indoor percussion ensembles throughout the WGI season. Videos, pictures, and rehearsal footage of the world's top ensembles!

www.PearlAdamsWGI.com



PHANTOM REGIMENT ROCKFORD, IL



MUSIC CITY MYSTIQUE NASHVILLE, TN



RHYTHM X COLUMBUS, OH



UNITED PERCUSSION CAMDEN, NJ



SPIRIT OF ATLANTA ATLANTA, GA



GEORGE MASON UNIVERSITY FAIRFAX, VA



SEATTLE CASCADES SEATTLE, WA



REDLINE INDOOR CANTON, MI



SPARTANS DRUM & BUGLE CORPS NASHUA, NH



GATEWAY INDOOR ST. LOUIS, MO



LEGACY INDOOR INDIANAPOLIS, IN



DARK SKY PERCUSSION LONG BEACH, CA



CENTER GROVE HS INDIANAPOLIS, IN



LOUISIANA STARS LAFAYETTE, LA



7TH REGIMENT NEW LONDON, CT



PETAL HIGH SCHOOL PETAL, MS

THE FFX LEGACY

A STANDARD OF EXCELLENCE

BEFORE THE BADGE GOES ON

Superior Shell Technology and Premium Materials Make all the Difference.

Pearl Concert Drums have set the standard of world class symphonic performance for over 30 years. Working with some of the world's greatest performers and orchestras, we have developed a collection of instruments that are unmatched in quality and dependability. The Philharmonic snare drums are the most successful concert drum series in history, with nearly every professional orchestra in the world boasting at least one drum in its inventory. The combination of clean design and simple operation, along with Pearl's SST shell technology, players are able to choose from a family of instruments that deliver on tone, projection, expression, color, and dynamics to suit any musical or environmental need.

Three complete lines of drums including the Concert, Symphonic, and Philharmonic Series, each offer a distinctly refined combination of material, configuration, and function. Whether you play in the finest concert halls in the world, the band room at your school, or even on the marching field of competition - there is a Pearl concert drum to perform at the highest level.



No other snare drum has changed the face of marching competition like the FFX Championship Series. No matter which of our premium shell designs are used, the truly Free-Floating design of the FFX sets the industry standard for dynamic range, sensitivity, and unsurpassed projection.

The FFX Aluminum Edge Ring frame gives you a top bearing edge that can take all of the pressure necessary for today's high tension heads. Without any mounting devices attached, the shell is free to enhance the tonal response, and focus the drum's maximum sensitivity and volume.

All Pearl Marching Shells are made using Pearl's Exclusive SST Superior Shell Technology.

LIMITED LIFETIME WARRANTY

Pearl Drums are designed and manufactured to provide the highest standards in quality, style, appearance and playing performance. Pearl takes pride in its products and takes great care to utilize the best materials and the highest standard of craftsmanship in their manufacture.

Pearl Concert Drum Shells are guaranteed against material failure, ply separation or going out of round for life. Pearl is proud to be one of the few drum companies in the world to offer a Limited Lifetime Warranty on our drum shells.



SUPERIOR SHELL TECHNOLOGY
ASSURES MANUFACTURING EXCELLENCE. EVERY TIME.

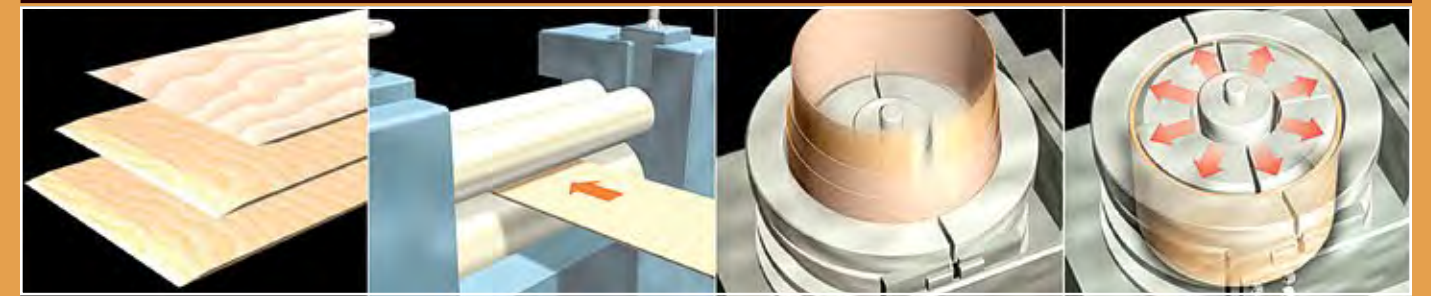

No inferior butt seams here. These tapered scarf joints seamlessly overlap for perfect shell resonance and consistency.

Our proprietary "AcoustiGlue" permeates the wood and hardens to the same consistency as the wood.

The scarf joints are carefully staggered upon insertion of the specially designed mold.

Extreme heat and over 1000 PSI pressure are simultaneously applied to the shell during formation.

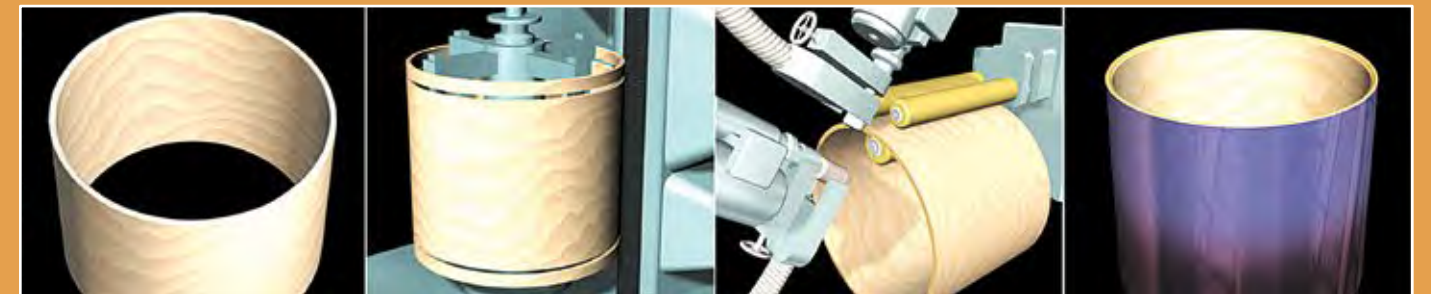

A perfect, gapless air chamber.

The shell is then trimmed and the ends squared to assure overall tuning consistency and head seal.

Our exclusive bearing edge incorporates a 45° out and 45° in, slightly inset from the exterior to optimize contact with the flat portion of the drum head.

Pearl's finishes are the industry state-of-the-art. Your choice of finish is encased in layers of highly durable urethane and polished to a high luster. Truly a work of art.

	PHILHARMONIC PHM	PHILHARMONIC PHP, PHF	PHILHARMONIC PBA	SYMPHONIC PBM, SYP, PTM	CONCERT PBE	PHILHARMONIC PHA	PHILHARMONIC PHB	PHILHARMONIC PTA	SYMPHONIC PTM	CONCERT PTE
SHELL MATERIAL:	Maple	Maple	African Mahogany	Maple	Kapur	Aluminum	Beaded Brass	African Mahogany	Maple	Poplar / Kapur
NUMBER OF PLYS:	1	6	6	6	6	1	1	6	6	6
THICKNESS (mm):	7.5	7.5	7.5	7.5	7.5	3.0	1.5	7.5	7.5	7.5
BEARING EDGE:	45°	45°	45°	45°	45°	45°	45°	45°	45°	45°



JOHN WOOTON
University of Southern Mississippi



JAMES SPARLING
Redline/Madison Scouts



JULIE DAVILA
Caixa Trio / PAS Board of Directors



RALPH HARDIMON
DCI Hall of Fame / The Blue Knights



JEFF PROSPERIE
Hellcats United States Military Academy



THOM HANNUM
Univ. of Massachusetts / DCI Hall of Fame



TIM FAIRBANKS
Rhythm X



ERIC WARD
Greater Glasgow Police Scotland Pipe Band



SHANE GWALTNEY
Music City Mystique

EXPERIENCE THE
PEARL
DIFFERENCE
in *MARCHING*
PERCUSSION



CarbonCore Snare and Tenors feature a 100% Maple Shell, with an added inner ply of ultra light Carbon Fiber. The added "CarbonCore" material takes these higher-frequency voices to their most expressive limits - clear and articulate at low volumes, crisp and powerful at high volumes. The warmth of tone given by 6-plyies of Maple, married with the boosted highs of the CarbonCore creates a brand new maximized Snare and Tenor sound. CarbonCore is the newest Pearl sound on the field, and an instant Championship Sound.

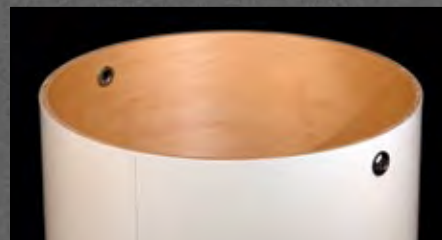

Championship Maple

is the industry standard in marching drums due to its range of frequency response and warmth in sound quality. Maple shells have a smooth, even texture that remains durable under a wide range of conditions and accepts a variety of rich lustrous finishes. Maple is the choice of champions - a full, articulate sound chosen by world class Marching Ensembles year after year.



Maple - Maple is the ideal choice for concert drums due to its range of frequency response and warmth in sound quality. It has a smooth, even texture that remains durable under a wide range of conditions. Maple accepts a variety of rich lustrous finishes, making it the choice of professionals and ensembles around the world.

Poplar / Kapur - The new blended Poplar and Kapur shells of the Concert and Competitor Series bring the economy and durability of Poplar together with the lush, full tonal response of Kapur - a material usually reserved for only high end instruments. The result is a drum with a strong attack and projection with outstanding lows and punch for any environment.

African Mahogany - African Mahogany delivers a dramatic boost in lower frequencies. This makes it the ideal choice for concert toms, bass drums and larger snare drums that need to deliver a dark, forceful tone that can be heard over an ensemble.

Kapur - The 100% Kapur shell of the PBE bass drum is the best sounding drum of its kind. Darker and fuller sounding than regular mahogany, the 6 plies of Kapur are ideal for bass drums in any ensemble.



Aluminum - At 3mm thick, our exclusive precision-milled PHA cast Aluminum shell snare drum has a full bodied tone, with a higher overall pitch response than traditional maple. Aluminum provides the warm, round, full-bodied resonance of a wood shell snare, but also possesses the snap, volume and projection provided by a metal snare.



Brass - PHB Philharmonic Brass offers the highest frequency response in the Philharmonic Series with bright cutting clarity and finesse. 1.5mm thick brass Philharmonic shells have a bright, highly focused, well balanced tone perfect for situations needing more volume and clarity.

TENORS BY THE NUMBERS

Tenor Sets are arranged in 7 different sized arrays to suit your physical and musical needs.

SONIC & SHALLOW CUT TENORS

Pearl offers 2 shell depth options for tonal and weight considerations:

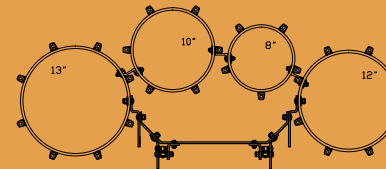

8023

Sonic Cut tenors are the full-length shells of the legendary Pearl sound. Best suited for outdoor playing and large ensembles - Sonic Cut gives you the maximum power and punch you need on the field.

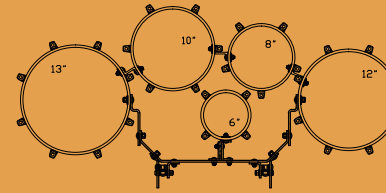

68023

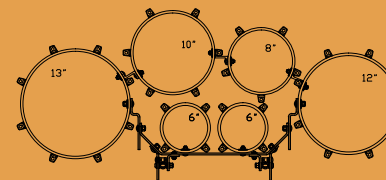

668023

Shallow-Cut tenors have shorter shell depths for reduced weight, and a naturally brighter upper-overtone response. Available in all diameters and configurations.

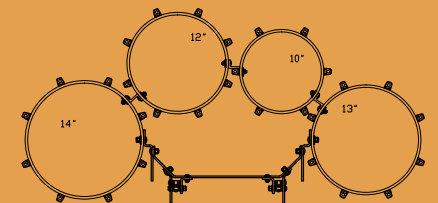

0234

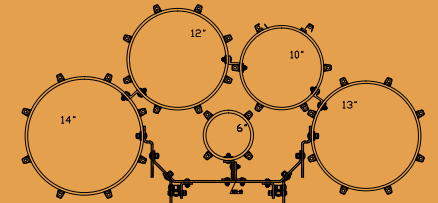

60234

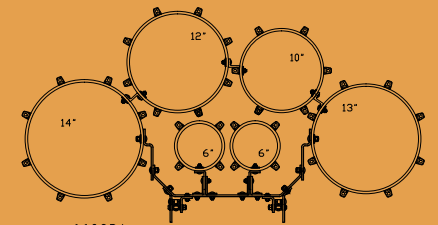

660234

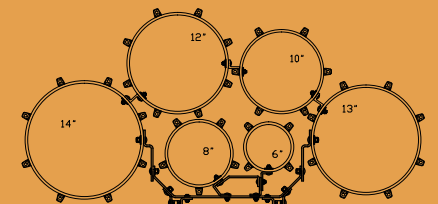

680234

	CARBONCORE SD	CARBONCORE TD	CHAMPIONSHIP SD	CHAMPIONSHIP BD	CHAMPIONSHIP TD	COMPETITOR CMSX SD	COMPETITOR CMS SD	COMPETITOR BD	COMPETITOR TD	FFXPMD PIPEBAND SD	PIPEBAND BD / TD	TRADITIONAL TENOR
SHELL MATERIAL	Maple**	Maple**	Maple	Maple	Maple	Poplar / Kapur	Poplar / Kapur	Poplar / Kapur	Poplar / Kapur	Birch	Maple	Maple
NO. OF PLYS	6	6	6	6	6	6	6	6	6	4	4	6
THICKNESS (mm)	7.5	7.5	7.5	7.5	7.5	7.5	7.5	7.5	7.5	5	5	7.5
R. RING	Yes (Bottom Only)	Yes (Top Only)	Yes (Bottom Only)	-	Yes (Top Only)	-	-	-	-	Yes	Yes (Top & Bottom)	Yes (Top & Bottom)
BEARING EDGE	45°	Fully Rounded (Top) Flat (Bottom)	45°	45°	Fully Rounded (Top) Flat (Bottom)	45°	Fully Rounded (Top) 45° (Bottom)	45°	Fully Rounded (Top) Flat (Bottom)	45°	45°	Fully Rounded (Top & Bottom)
	**with inner Carbon											



DREW DUTHART
Scottish-Lion 78th
Fraser Highlanders



JIM KILPATRICK
Independent / Pipe Drumming Legend



JAMES ANCONA
University of Delaware/Carolina Crown



JOSHUA TORRES
Center Grove High School



MICHAEL EAGLE
Independent



JIM CASELLA
Independent /
Tapspace Publications



NICK ANGELIS
University of Cincinnati



NEAL FLUM
University of Alabama



FFXML1412/B982
#982 Black/Silver Fade Top

CHAMPIONSHIP BLACK OUT

Introducing the all new Black Out Powdercoat Hardware line-up to Championship Series Marching Percussion. Black Powdercoat hardware adds a touch of drama to your Varsity or Custom finish drums and pushes your school's spirit over the goal line.

Utilizing the highest quality materials and equipment, technicians apply the durable Powdercoat finish in a closely monitored, custom-built, single-purpose facility, assuring you the fastest delivery and performance that only Pearl Championship drums can achieve.

Hard-hitting, dramatic,
with the strength to go the distance –
there is nothing like a Black Out finish
“Win” for your Championship line.



FFXML1412/B966 #966 Red/Silver Burst

VARSITY



The NEW Varsity Wrap Series for Pearl Championship Marching drums makes showing your school spirit fast and easy!

The Varsity series kicks off the 2017 season with 8 vibrant high gloss sparkle wrap finishes in the standard scholastic color palette for all Pearl Championship Wrap series drums. Choose your school color and pick from Fade Top, Fade Bottom, and Burst styles that best fit your school's spirit.

	Fade Top	Fade Bottom	Burst
Blue / Silver	#962	#961	#960
Yellow / Silver	#965	#964	#963
Red / Silver	#968	#967	#966
Green / Silver	#971	#970	#969
Garnet / Silver	#974	#973	#972
Purple / Silver	#977	#976	#975
Orange / Silver	#980	#979	#978
Black / Silver	#982	#981	#983

Varsity Wrap Finishes will be available beginning in 2017 on all Championship drums including CarbonCore and Championship Maple Series Drums.



Fade Top / #962



Fade Bottom / #961



Burst / #960

Please Note: Patterns listed refer to the snare drum only. Regardless of finish pattern chosen, tenors will always be Top Down fades, and bass drums will always be Burst.

carboncore®
THE MAGIC'S INSIDE

CHAMPIONSHIP CARBONCORE SNARE DRUMS



FFXCC1412/A983 #983 Black Silver Burst

A Marching Battery produces a broad range of frequencies, from the lows in the Bass Drums all the way up to the highs in the Snare Drums and smallest Tenor Drums. Championship CarbonCore maximizes the clarity and projection of the Marching Battery across this entire range.

CarbonCore Snare Drums feature a 100% Maple Shell, with an added inner ply of ultra-light Carbon Fiber. The added "CarbonCore" enhances the expressive capability of the Snare Drum across its full dynamic range – clear and articulate at low volumes, crisp and powerful at high volumes. The warmth of tone given by 6 plies of Maple married with the boosted high frequencies given by the CarbonCore, together create a newly maximized Snare Drum for the Marching Arts.



FFXCC1311/A983 #983 Black Silver Burst

FEATURES

- 6 Plies of 100% Maple
- 1 Inside Ply of Light Weight Carbon Fiber
- 2 ply Snare Side Reinforcement Rings for Added Strength
- Fully Free-Floating Design
- Built to Withstand High Tension Usage
- 16 Strand Synthetic Gut Snare, Individually-Tunable
- Stock Finish: #103 Piano Black Lacquer

SIZES

- FFXCC1412/A 14" x 12"
• The Standard. Full-sized sound and projection.
- FFXCC1311/A 13" x 11"
• Higher pitch range than 14" counterparts, but lighter in projection and weight.

CHAMPIONSHIP CARBONCORE TENOR DRUMS



PMTCC80234/A983 #983 Black Silver Burst

CarbonCore Tenors are made with 100% Maple Shells, each having an added inner ply of ultra-light Carbon Fiber. The added "CarbonCore" gives the Tenor section a unique EQ'ed place in the sonic mix of the Battery, which holds its own ground for expression between the Bass Drums and Snare Drums. Each drum in a CarbonCore Tenor set comes to vibrant life with an even-clearer articulation and more confident projection than ever before. On all drum sizes and across the full dynamic range, Championship CarbonCore Tenors are audible and beautiful.

FEATURES

- 6 Plies of 100% Maple
- 1 Inside Ply of Light Weight Carbon Fiber
- 2 ply Reinforcement Rings for Added Strength
- Fully Rounded Bearing Edges for Superior Tone
- Available in Sonic or Shallow Cut Options
- 2.3 mm Solid Steel SuperHoop II Rims
- 3 Year Warranty on Shell / 1 Year Warranty on Hardware
- Stock Finish: #103 Piano Black Lacquer
- Available in 62 Wrap & Hi-Gloss Lacquer Finishes by Special Order

HARDWARE OPTIONS

- Polished Aluminum (Standard)
- Chrome*
- Powder Coat*

* Available by Special Order

CarbonCore Sonic Cut Sets Available

CarbonCore Shallow Cut Sets Available

SIZES

PMTCC8023/A	QUAD	8"/10"/12"/13"
PMTCC0234/A	QUAD	10"/12"/13"/14"
PMTCC68023/A	QUINT	6"/8"/10"/12"/13"
PMTCC60234/A	QUINT	6"/10"/12"/13"/14"
PMTCC668023/A	SEXTET	6"/6"/8"/10"/12"/13"
PMTCC660234/A	SEXTET	6"/6"/10"/12"/13"/14"
PMTCC680234/A	SEXTET	6"/8"/10"/12"/13"/14"

SIZES

PMTCC8023/A	QUAD	8"/10"/12"/13"
PMTCC0234/A	QUAD	10"/12"/13"/14"
PMTCC68023/A	QUINT	6"/8"/10"/12"/13"
PMTCC60234/A	QUINT	6"/10"/12"/13"/14"
PMTCC668023/A	SEXTET	6"/6"/8"/10"/12"/13"
PMTCC660234/A	SEXTET	6"/6"/10"/12"/13"/14"
PMTCC680234/A	SEXTET	6"/8"/10"/12"/13"/14"

DRUM SIZE	SONIC CUT DEPTH	SHALLOW CUT DEPTH
6	8	8
8	8	8
10	10	9
12	12	10
13	12	10
14	13	11



CHAMPIONSHIP MAPLE BASS DRUMS

Maple Bases are the perfect complement to CarbonCore Snares and Tenors. Unparalleled warmth, depth, tone, and full projection characteristic of these 100% Maple shell Bass Drums complete the CarbonCore sound and give your Marching Battery the ultimate foundation. Stocked in #103 Piano Black lacquer to match.

For available sizes, features, and more information on Championship Maple Bass Drums, turn to page 14.

CARBONCORE® SHELL



100% Maple Shell with an added inner ply of ultra light Carbon Fiber. The added "CarbonCore" material takes these higher-frequency voices to their most expressive limits.



#1 IN TONE,
FUNCTION+PROJECTION

CHAMPIONSHIP MAPLE
FFX SNARE DRUMS



It's called Championship Series for a reason. Untouchable by its competitors, absolutely committed to Being the Best. Championship Maple drums stand out as #1 in tone, physical function, and projection. Every drum in the series is designed to its lightest possible weight so performers can push the envelope of visual performance while producing the very best sounds.

Pearl's FFX Snare Drums are the crown jewels of the Championship Series. They are the total package: lightweight mobility, clear projection, and complete richness of sound. A fully Free-Floating design allows unhindered shell response from the 6 ply 100% Maple shell that "floats" in a super lightweight aircraft aluminum frame. The FFX is the best in its class and is competitively proven having contributed to more than a few High Percussion Awards. Championship Maple Series - *Proven trophy magnets year after year.*

FFX ONETOUCH SNARE RELEASE



The patent pending FFX OneTouch Snare release features smooth, effortless one finger snare release action and a precision pull-to-engage locking mechanism, all in an elegantly simplified light weight design. Virtually all moving parts have been eliminated with the OneTouch Snare release for maximum durability and lightest weight performance. One-Way Snare assemblies go on quickly and can only be engaged when installed in the correct position, eliminating set-up errors and making tuning and changing heads simple and easy.

INTRODUCING THE
LIGHTEST, FASTEST,
MOST AGILE FFX EVER.



Dr. John Wooton - University of Southern Mississippi

The classic Pearl Championship Snare Drum for over 25 years has been re-engineered for unprecedented agility and now features our revolutionary OneTouch snare release resulting in over 2 lbs. of weight reduction.

FEATURES

- 6 ply 100% Maple Shell
- Free-Floating Design
- Lightweight Aircraft Aluminum Frame
- Aluminum Alloy Edge Ring and Hoops to Withstand the Highest Tensions
- Individually Tunable Snares
- One Knob Quick Release Strainer Allows Fast Head Changes
- 6 Acoustically Located Air Vents
- 3 Year Warranty on Shells / 1 Year Warranty on All Hardware
- Chrome or Powder Coated Hardware Available

SIZES

FFXML1412/A	14" x 12"
Lacquer/Varsity	
FFXM1412/A	14" x 12"
Covered Finish	
FFXML1311/A	13" x 11"
Lacquer/Varsity	
FFXM1311/A	13" x 11"
Covered Finish	



FFXML1412/A977
#977 Purple/Silver Fade Top



6-Ply 100% Maple Shell
Clear projection and complete richness of sound



Aluminum Alloy Edge Ring and Hoops to Withstand the Highest Tensions



S21ROTRA Strainer (butt side)
16 strand synthetic gut snares Individually tunable
S21ROTBA Strainer (release side)

CHAMPIONSHIP BASS DRUMS



6 ply 100% Maple shells offer maximum resonance and huge sub-frequency projection. To compliment the Maple shells, 2" wide Maple Hoops are secured by extra wide claws that disperse tension over a larger area for consistent tuning. Lightweight high strength one piece cast aluminum casings and 6 mm case hardened tension bolts provide uncompromising strength while still keeping you light on your feet.

PBDM2014/A33
#33 Pure White

FEATURES

- 6 ply 100% Maple Shell
- 2" Wide Maple Hoops
- Remo Smooth White Ambassador® Heads w/Logo
- Die-Cast Aluminum Alloy Casings
- Oversized Triple Reinforced Claws
- 100% Maple 2" Wide Matte Black Hoops
- 6 Acoustically Located Air Vents
- 6 mm Case-Hardened Tension Bolts
- 3 Standard Covered Finishes
- Available in 56 High Gloss Lacquer Finishes*
- Available in Varsity and Special Order Coverings*
- 1 Year Hardware Warranty / 3 Year Shell Warranty
*Special Order Only

SIZES

PBDM1414/A	14" x 14"
PBDM1614/A	16" x 14"
PBDM1814/A	18" x 14"
PBDM2014/A	20" x 14"
PBDM2214/A	22" x 14"
PBDM2414/A	24" x 14"
PBDM2614/A	26" x 14"
PBDM2814/A	28" x 14"
PBDM3016/A	30" x 16"
PBDM3216/A	32" x 16"

CHAMPIONSHIP TRADITIONAL TENOR



The PTD Traditional Tenor Series is the answer for all drumlines using single drums in either vertical sling, or fully horizontal bass-style positions. 100% 6-ply Maple Shells and Die-Cast Aluminum lug casings provide the sound and durability to match the FFX snares, PMT tenors and PBD Basses of the Championship Maple Series.

PTDM1412/A33
#33 Pure White

FEATURES

- 6 Ply 100% Maple Shell
- 2 Ply Maple Reinforcement Ring
- Fully Rounded Bearing Edges
- 8 Aluminum Die Cast Lugs
- 2.3 mm SuperHoop II
- Stock Wrap Colors #33, #46, #450

SIZES

PTDM1412/A	14" x 12"
PTDM1512/A	15" x 12"
PTDM1614/A	16" x 14"

CHAMPIONSHIP TENORS SONIC CUT



PMTM680234/A46
#46 Midnight

FEATURES

- 6 ply 100% Maple Shell
- 2 ply Maple Reinforcement Rings
- Fully Rounded Bearing Edges for Optimal Tone
- Features Pearl's Sonic Cut for Volume & Projection
- 2.3 mm Solid Steel SuperHoop II Rims
- Rubber Tom Trim for Shell Protection
- 6 mm Case Hardened Tension Bolts
- Available in 3 Standard Covered Finishes
- Available in 56 High Gloss Lacquer Finishes*
- Available in Varsity and Special Order Coverings*
- 1 Year Hardware Warranty / 3 Year Shell Warranty
*Special Order Only

SIZES • Sonic Cut Sets Available

PMTM8023/A	QUAD	8" 10" 12" 13"
PMTM0234/A	QUAD	10" 12" 13" 14"
PMTM68023/A	QUINT	6" 7" 8" 10" 12" 13"
PMTM60234/A	QUINT	6" 10" 12" 13" 14"
PMTM668023/A	SEXTET	6" 6" 8" 10" 12" 13"
PMTM660234/A	SEXTET	6" 6" 10" 12" 13" 14"
PMTM680234/A	SEXTET	6" 8" 10" 12" 13" 14"

DRUM SIZE	SONIC CUT DEPTH	SHALLOW CUT DEPTH
6	8	8
8	8	8
10	10	9
12	12	10
13	12	10
14	13	11

Pearl Championship Sonic Cut is renowned for its exceptionally full tenor sound. Fully rounded bearing edges give a focused character to the sound, while the Sonic Cut of each shell provides outstanding projection and volume. 2.3mm SuperHoop II rims and case-hardened tension bolts are made to be exceptionally strong and handle the rigors of even the most aggressive tuning schemes.

CHAMPIONSHIP TENORS SHALLOW CUT



PMTMS60234/A33
#33 Pure White

FEATURES

- 6 ply 100% Maple Shells for Strength & Richness
- Shells with Shallow Cut Provides Extreme Focus & Articulate Response
- Rounded Bearing Edges Deliver Classic Pearl Tone
- Lightweight = Increased Mobility
- 2 ply Reinforcement Rings

SIZES • Shallow Cut Sets Available

PMTMS8023/A	QUAD	8" 10" 12" 13"
PMTMS0234/A	QUAD	10" 12" 13" 14"
PMTMS68023/A	QUINT	6" 7" 8" 10" 12" 13"
PMTMS60234/A	QUINT	6" 10" 12" 13" 14"
PMTMS668023/A	SEXTET	6" 6" 8" 10" 12" 13"
PMTMS660234/A	SEXTET	6" 6" 10" 12" 13" 14"
PMTMS680234/A	SEXTET	6" 8" 10" 12" 13" 14"

Championship Shallow Cut Marching Toms shell design provides tight focus while reducing overall mass for fast moving high energy performances. Maple Shells deliver rich, robust sound while the rounded bearing edges deliver that distinctive Pearl sound. Case-hardened Aluminum tension casings offer improved tuning accuracy and even dispersion of tension while 6 mm case hardened tension bolts permit the highest tunings without failure.



SLG100
Triple Function Sling is designed for use with all snare and traditional tenor drums



LR60
Locking Leg Rest for Snare and Tenors up to 20"

HIGH VALUE
AFFORDABLE PRICE

COMPETITOR SNARE DRUM CMSX

CMSX1412/C33
#33 Pure White



The CMSX Snare Drum offers many features of the FFX Series Snare Drums, such as a free-floating shell with an aluminum edge ring, which relieves all batter head tension from the 6-ply shell, and polished aluminum tension posts for a classy, sleek look.

FEATURES
• 6 ply Poplar / Kapur Shells
• Lightweight Construction
• 2.3 mm Triple Flanged SuperHoop II
• Available in 13" and 14" Sizes
• CMSX Aluminum Edge Ring Relieves Shell Tension
• CMSX Compatible with CXS and MXS carriers
• Ultra Sensitive 12 Strand Synthetic Snares
• Lever Activated Snare Strainer
• Standard Covered Finishes: #33 Pure White, #46 Midnight Black

SIZES & FINISHES
CMSX1412/C 14" x 12"
CMSX1311/C 13" x 11"



Competitor Series offers high value results at an affordable price. New features include upgraded construction on the entire Series with composite shells of durable Poplar and full sounding Kapur. Competitor Series is also tremendously light weight for Marching Drums, a sure benefit for any band who has smaller players or needs to be extra light on their feet. Take the field with a Marching Battery of incredible quality, without incredible weight!

COMPETITOR SNARE DRUM CMS

CMS1309/C46
#46 Midnight Black



The CMS Snare Drum offers Pearl quality at the lightest weight of any Marching Drum available. Constructed using the same Superior Shell Technology (SST) as Pearl's Championship Series, you can be sure that CMS Snare Drums will deliver crisp response reliably through years of use. Chrome 3-part full-length Die Cast lugs and triple-flanged steel hoops make tuning a breeze, and built in snare guards on each side of the bottom hoop add built in protection to CMS Snare Drums. The perfect choice for any band wanting to use Mylar drumheads for that classic Marching Battery sound.



6-Ply Poplar / Kapur Shell
Durability of Poplar with lush, full tonal response of Kapur

Lever Activated Snare Strainer

CT1216 Clip Mount



FEATURES
• 6 ply Poplar / Kapur Shells
• Lightweight Construction
• 1.6 mm Triple Flanged Steel Hoops
• Available in 13" and 14" Sizes
• Ultra Sensitive 12 Strand Synthetic Snares
• Lever Activated Snare Strainer
• Standard Covered Finishes: #33 Pure White, #46 Midnight Black

SIZES & FINISHES
CMS1412/C 14" x 12"
CMS1309/C 13" x 9"

COMPETITOR BASS DRUMS

COMPETITOR TENORS



CMB1814N/C33
#33 Pure White

CMB2814N/C33
#33 Pure White

Pearl's Competitor Series Bass drums offer tremendous value and performance. Upgraded construction with composite shells of durable Poplar and full sounding Kapur featuring 6 strategically placed air vents make these drums highly efficient low frequency projectors. Durable 6 ply maple hoops, triple-reinforced claws, and high-strength marching lugs assure perfect tuning season after season.

- FEATURES**
- 6 ply Poplar / Kapur Shells
 - 6 ply Matte Black Maple Hoops for a Classic Finish
 - 6 Acoustically Located Air Vents
 - Lightweight for Increased Mobility
 - Chrome 3-Part Full-Length Marching Lugs
 - 8 Sizes Available
 - Standard Covered Finishes:
#33 Pure White, #46 Midnight Black

- SIZES**
- | | |
|------------|-----------|
| CMB1414N/C | 14" x 14" |
| CMB1614N/C | 16" x 14" |
| CMB1814N/C | 18" x 14" |
| CMB2014N/C | 20" x 14" |
| CMB2214N/C | 22" x 14" |
| CMB2414N/C | 24" x 14" |
| CMB2614N/C | 26" x 14" |
| CMB2814N/C | 28" x 14" |



CMT8023N/C46
#46 Midnight Black

Competitor Tenors offer extreme value and performance to put your Band in the Winner's Circle. New additions include upgraded construction with composite shells of durable Poplar and full sounding Kapur feature a rounded bearing edge like Championship Drums for a robust yet projecting tone. Pearl's sonic cut on the shell bottoms project that big sound right to your audience.



CMT802N/C46
#46 Midnight Black

The lightweight zinc lug casings provide precise even tuning. The bottoms of the shells are protected by rubber Tom trim, and lightweight aluminum Tom spacers keep positioning perfect.

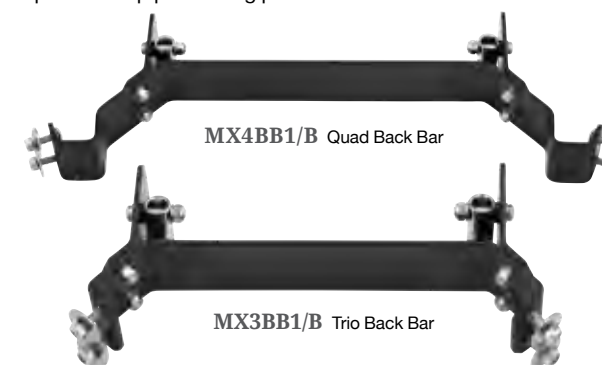

SIZES

CMT802N/C	TRIO	8/10/12
CMT8023N/C	QUAD	8/10/12/13

- FEATURES**
- 6 ply Poplar / Kapur Shells
 - Aluminum Tom Spacers
 - Fully Rounded Bearing Edges
 - Pearl's Sonic Cut for Amazing Projection
 - Includes Rubber Tom Trim for Shell Protection
 - Lightweight Construction
 - Chromed Zinc Lug Casings
 - Steel Triple Flanged Hoops
 - CMT Tenors Compatible with MXT carriers
 - Drum & Carrier Packages Available
 - Standard Covered Finishes:
#33 Pure White, #46 Midnight Black

MX QUAD & TRIO BACK BAR
Tenor rails are available in Quad or Trio configurations. Both feature precise level mounting of toms and provide tilt up function & detach quickly from the carrier J rods.



**LIGHTWEIGHT FOR
YOUNG PERCUSSIONISTS**



JUNIOR MARCHING SERIES DRUMS

Get your aspiring young drummer on the field with the Junior Marching Series Carrier, designed to comfortably fit the smallest of body frames. Furthermore, Junior Marching Series snares and tenors are compatible with Pearl's MX T-frame carrier, providing a lightweight battery option for the conventional corps, pep band, and scramble-band alike.

Pearl's Junior Marching Series' Poplar shells provide durability, while the age-appropriate sizes allow for even the smallest players to experience the joy and excitement of playing marching drums. Field-ready right out of the box, Junior Marching Series drums are finished in a classic #33 Pure White wrap and packaged with a matching pre-assembled white powder-coated carrier. Pearl's Junior Marching Series battery is a must have for any elementary or middle school music program.



JUNIOR MARCHING SNARE DRUMS

MJS1007/CXN33
#33 Pure White

MJS1208/CXN33
#33 Pure White



FEATURES

- Available in #33 Pure White w/ Carrier pre-assembled
- Poplar Wood Shells
- Ovular Championship-style badge
- Lighter Weight for Elementary and Middle School Students
- MCH Carrier Included, white powder-coat
- Pearl CC/ST heads
- 1.6mm Steel Rims
- MX Series Carrier compatible

SIZES

MJS1007/CXN33	10" x 7"	4.85 lbs
MJS1208/CXN33	12" x 8"	5.95 lbs

JUNIOR MARCHING TENORS

FEATURES

- Available in #33 Pure White w/ Carrier pre-assembled
- Poplar Wood Shells
- Ovular Championship-style badge
- Lighter Weight for Elementary and Middle School Students
- MCH Carrier Included, white powder-coat
- Pearl CC heads

SIZES

MJT1007/CXN33	10" x 7"	4.70 lbs
MJT1208/CXN33	12" x 8"	5.80 lbs



MJT1208/CXN33 #33 Pure White

JUNIOR MARCHING TRI-TOM

FEATURES

- #33 Pure White w/ Carrier pre-assembled
- Poplar Wood Shells
- Ovular Championship-style badge
- Lighter Weight for Elementary and Middle School Students
- MCH Carrier Included, white powder-coat
- Pearl CC heads
- 1.6mm Steel Rims
- MX Series Carrier compatible

SIZES

MJT680/CXN33	6", 8", 10"	9.90 lbs
--------------	-------------	----------



MJT680/CXN33 #33 Pure White

JUNIOR MARCHING BASS DRUM



MJB1808/CXN33
#33 Pure White

FEATURES

- #33 Pure White w/ Carrier pre-assembled
- Poplar Wood Shells
- Ovular Championship-style badge
- Lighter Weight for Elementary and Middle School Students
- MCH Carrier Included, white powder-coat
- Pearl CC heads

SIZES

MJB1408/CXN33	14" x 8"	6.20 lbs
MJB1608/CXN33	16" x 8"	7.10 lbs
MJB1808/CXN33	18" x 8"	7.70 lbs
MJB2008/CXN33	20" x 8"	8.80 lbs

JUNIOR MARCHING CARRIERS



MCH20S

MCH20B

FEATURES

- Preassembled out of box
- #33 Pure White powder-coated
- MX T-frame style construction

MCH Carriers not sold separately

SIZES

MCH20S	Snare/Tenor Drum Carrier
MCH20B	Bass Drum Carrier

MEDALIST

Championship Pipe Drums combine the ultimate in build quality, tunability, and appearance. The free-floating Birch shells of Championship Pipe Snare Drums deliver the “crack” and “snap” that make your tunes groove, while also providing the most expressive canvas for low-dynamic playing. Paired with the warmth of Maple Tenors and Maple Bass Drums, the Championship Pipe Battery gives a fantastic sonority across the entire frequency range. Walk onto the competition field with full confidence.

Pearl Championship Pipe Series...
the chosen Instruments of Champions.



Greater Glasgow Police Scotland
Pipe Band • Glasgow, Scotland

The new Championship “Medalist” Snare Drum is the lightest in its class, just 6.25Kg / 13.8lbs. The reduction in weight has been reached by looking into every detail of the snare. Firstly the shell construction; it’s an 100% Birch 5.0mm even 4 ply shell which resulted in a huge weight reduction. Secondly, the top and bottom strainer have been redesigned which resulted in a 35% weight reduction compared to our previous model.

Next to the reduction in weight other improvements have been made. Pearl has created new Snare Wires which are meticulously soldered, placed and even tensioned. All the Aluminum hardware including the aluminum alloy edge rings and rims are now fitted with our new Shiny Anodized finish, which give the drums a brilliant finish at the same time a durable and easy to maintain finish; to withstand all weather conditions.



CX AIRFRAME PIPE CARRIER
CXSP1 • U.S. Patent #7671261

- FEATURES**
- 100% Birch 4 ply + 2 ply Reinforcement Rings
 - New “Lightest Pipe Band Snare Drum, Ever!” Just 6.25Kg / 13.8lbs
 - New Design Top & Bottom Strainers, Weight Reduction Over 35%
 - Chrome Snare Wires for Increased Brightness
 - New Shiny Anodized Hardware Finish
 - High Tension Aluminum Alloy Edge Rings and Counter Hoops
 - 45 Degree Bearing Edge for a Great Cutting Sound
 - Remo Cybermax Kevlar® Head
 - Compatible with Pearl MX T-Frame and CX Airframe Carriers

- SIZES & FINISHES**
- FFXPMD1412 14" x 12"
Birch Shell, Polished
Aluminum Hardware
- Standard Lacquer Finishes:*
#109 Arctic White
#110 Sequoia Red
#122 Black Mist
#126 Emerald Mist

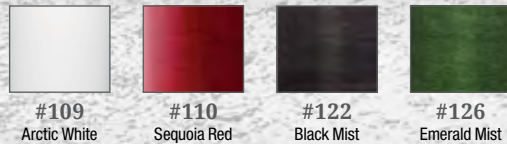

CHAMPIONSHIP PIPE SNARE DRUM



FFXPMD1412 126
#126 Emerald Mist



100% Birch Shell



Top Snare Mechanism



Bottom Snare Strainer

CHAMPIONSHIP PIPE TENOR



TDP1412 110
#110 Sequoia Red

Championship Pipe Band Tenor shells are comprised of 4 plies of Maple with 4 ply Maple Reinforcement Ring, 1" Maple hoops, and Aluminum Tube Lugs for great tone and lighter weight. Extended range and sizes are now available to meet the tonal range required in contemporary pieces. The case-hardened tension rods provide consistent head tensioning and the top and bottom heads are independently adjustable. Includes a carrying hook and is compatible with our SLG100 Triple Function Sling and LR60 Leg Rest.

FEATURES
• 4 ply Maple Shells with 4 ply Maple Reinforcement Ring
• 1" Maple Hoops
• Die Cast Rubber Insulated Claws
• Compatible with SLG100 Sling & LR60 Leg Rest
• High-Gloss Lacquer Finishes
#109 Arctic White, #110 Sequoia Red
#122 Black Mist, #126 Emerald Mist

SIZES
TDP1412 14" x 12"
TDP1512 15" x 12"
TDP1612 16" x 12"
TDP1812 18" x 12"
TDP2012 20" x 12"
TDP2014 20" x 14"
TDP2212 22" x 12"
TDP2214 22" x 14"

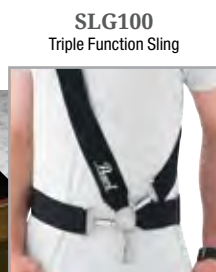

CHAMPIONSHIP PIPE BASS PB & BDP

Championship Pipe Band Bass drums give you full low frequencies with resounding warmth. The 4 ply Maple shells with 4 ply Maple Reinforcement Ring with 1.5" Maple hoops are meticulously finished in high gloss lacquers in both series of Pipe Bass drums. BDP Series basses have Aluminum Tube Lugs for maximum resonance and reduced weight. PB Series Drums have a 3 part cast lug that runs the full length of the shell for a more economical choice. Both Series are compatible with either CX or MX Series Carriers.



Greater Glasgow Police Scotland Pipe Band • Glasgow, Scotland



BDP2814 122 #122 Black Mist



PB2814N/C126 #126 Emerald Mist

BDP FEATURES
• 4 ply Maple Shells with 4 ply Maple Reinforcement Ring
• 1.5" Maple Hoops
• Full Length Aluminum Tube Lugs
• Die Cast Rubber-Lined Claws
• 3 Acoustically Placed Air Vents
• Carrying Hook
• Compatible with CXB or MXB Carriers
• High Gloss Lacquer Finishes

SIZES
BDP2612 26" x 12"
BDP2812 28" x 12"
BDP2814 28" x 14"
BDP2816 28" x 16"
BDP3016 30" x 16"

PB FEATURES
• 4 ply Maple shells with 4 ply Maple Reinforcement Ring
• 1.5" Maple Hoops
• Oversized Triple Reinforcement Claws
• Full Length 3-Part Die Cast Lugs
• 45° Angle-Cut Bearing Edges
• Compatible with CXB or MXB Carriers
• High Gloss Lacquer Finishes

SIZES
PB2812N/C 28" x 12"
PB2814N/C 28" x 14"
PB2816N/C 28" x 16"

Die Cast Rubber-Lined Claws

Full Length Aluminum Tube Lugs

Oversized Triple Reinforcement Claws

Full Length 3-Part Die Cast Lugs

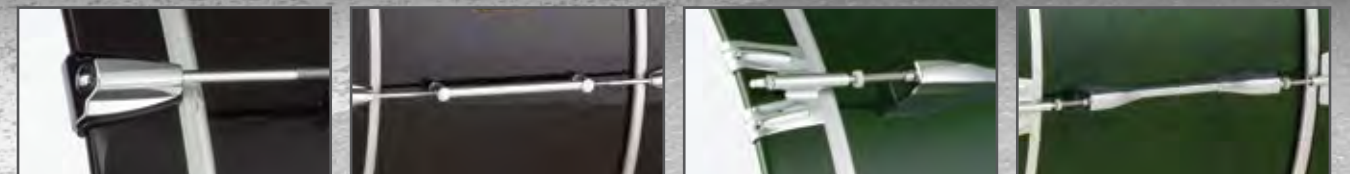

ELEGANTLY SIMPLE
INCREDIBLY SOLID



CX AIRFRAME CARRIER CORPUS EXTREME

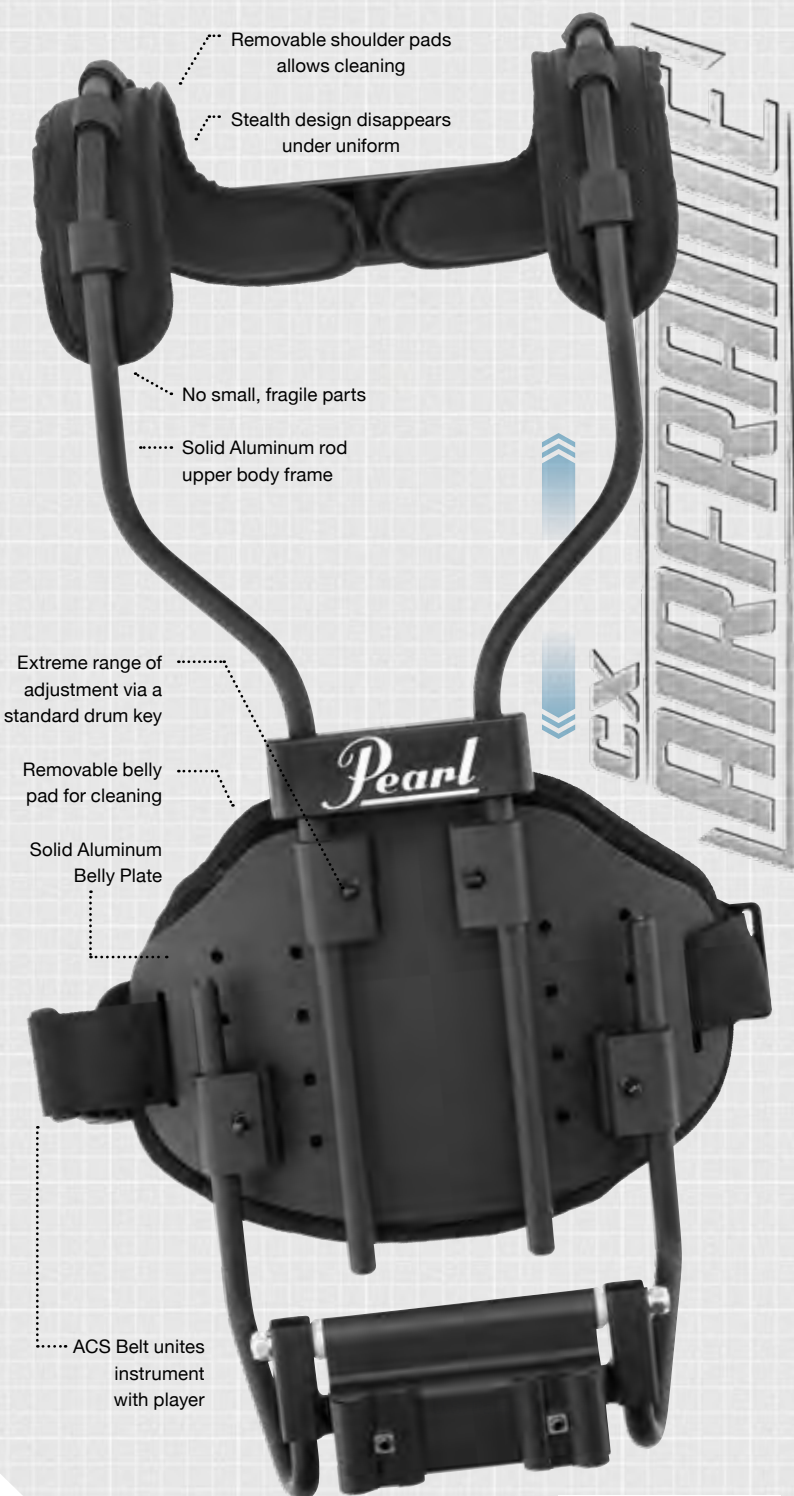

Removable shoulder pads allows cleaning
Stealth design disappears under uniform

No small, fragile parts
Solid Aluminum rod upper body frame

Extreme range of adjustment via a standard drum key

Removable belly pad for cleaning

Solid Aluminum Belly Plate

ACS Belt unites instrument with player

UPGRADED:

New additions include Tenor Agility J-rods (patent pending) that increase upper leg range of motion for tenor players by reducing the J-rod profile between the belly plate and the back bar. Modern body movement is no longer a fight between the drum and the player. The simple and efficient construction unites the drum and player in a common purpose, and looks good under a uniform at the same time.

CXB1 BASS CARRIER



CXB1

INCLUDES CXBB1/B
CXT1 TENOR CARRIER



CXT1 w/ CXBB1/B

INCLUDES CXSA2
CXS1 SNARE CARRIER



CXS1 w/ CXSA2

CXSA2

Pearl's CXSA2 snare attachment provides rigid mounting stability for all free floating snares. The attachment has the ability to angle drums with full tilt up function, and lifts quickly off the J-rods when at rest.

CXBB1/B TENOR BACK BAR

Pearl's CXBB1/B Tenor back bar provides absolute level positioning of all your toms. It permits pinpoint placement and perfect height adjustment with full ease of movement due to its lightweight aluminum construction.



Finally! A carrier that combines lightweight simple design with rugged durability: CX Airframe. A revolutionary breakthrough in carrier design featuring a solid rod form-fitting upper body frame attached to a lightweight aluminum belly plate.

The plush shoulder and belly pads are removable for cleaning and are built with a "stealth" design that allows CX Carriers to practically disappear under uniforms.

The ACS Agility Control System Belt (pictured above) performs two important functions: 1) it reduces back strain by transferring the weight of the instrument to the players hips, thereby reducing fatigue and the chance of injury by lowering the center of gravity; and 2) it unites the player to the instrument for unencumbered performance, allowing players to more easily meet the movement demands of contemporary drill design.

Highly adjustable, with minimal moving parts make this the carrier for players of all sizes and skill levels.

CXBB1 can be adjusted into 4 different positions to allow both 6" and 8" drums.





MX T-FRAME CARRIER

Every part has a purpose. Nothing left to take away for pure performance. Explore the range of capabilities the MX T-Frame offers.

Superior comfort ...

Easy to conceal
under uniform

Lightweight, sleek
form-fitting design

Adjusts to fit
any player

Rugged durability

Optimal positioning
for instruments

MXSA1 Snare
mount with
tilt up function

MXS1 Snare Carrier



BASS CARRIER

TENOR CARRIER

PIPE SNARE CARRIER



MXB1

MXT41 including MX4BB1/B

MXSP1 Includes AL72 Pipe J Hooks and CXSA2 SN Attachment

MX T-FRAME MARCHING EXTREME CARRIER

The Pearl MX T-Frame carriers offer elegant simplicity combined with solid dependability. These super light frames provide sleek comfort with a wide range of adjustability to fit every size player. A straight forward adjustment with minimal hardware make these carriers the clear choice for any band, and is ideal for smaller players.



MXSA1 Tilting Snare Mount
Compatible with FFX, CMSX, CMS Snare Drums

MXSA1 SNARE MOUNT

MXSA1 Snare mount allows secure mounting of both Free Floating FFX and CMSX drums and Spade mounts like the CMS Competitor Snare. The Tilting attachment provides a quick flip up function and allows for tilt positioning.



MX4BB1/B Quad Back Bar



MX3BB1/B Trio Back Bar

MX QUAD & TRIO BACK BAR

Tenor rails are available in Quad or Trio configurations. Both feature precise level mounting of toms and provide tilt up function & detach quickly from the carrier J rods.



MARCHING BASS STAND

FEATURES

- Height/Range Adjustable Double-Braced Front Leg
- 4-Arm Adjustable Basket
- Oversized No-Slip Rubber Feet
- Wide Open-Stance Rear Legs Allows Standing Room
- Easy To Operate Height Adjustment

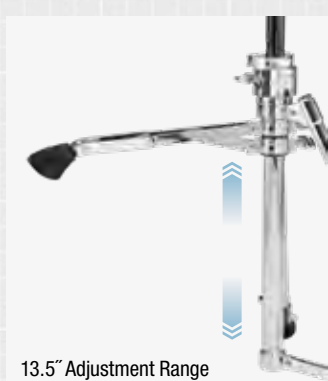

13.5" Adjustment Range

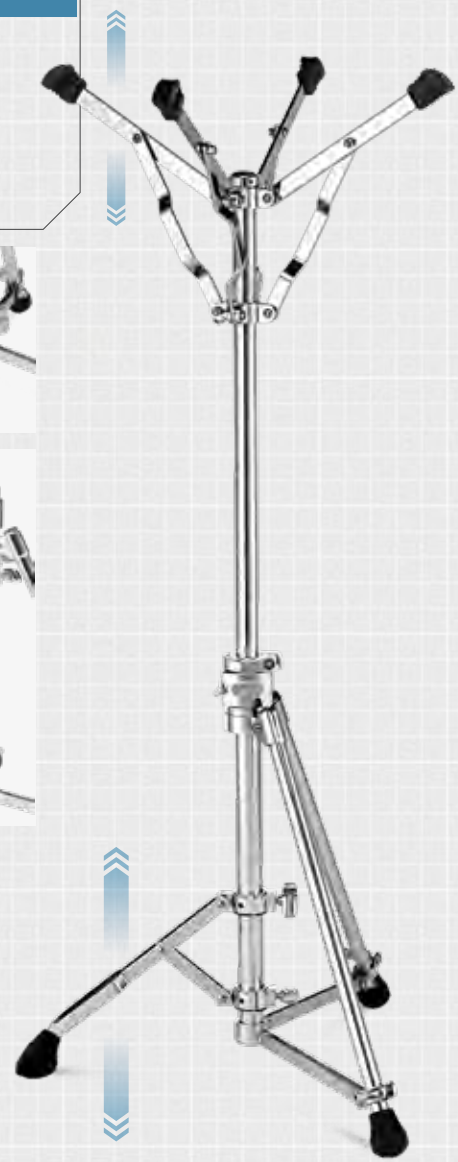

MBS3000

MARCHING SNARE STAND

FEATURES

- 13.5" Height/Range Adjustable Double-Braced Front Leg
- Oversized No-Slip Rubber Feet
- Wide Open-Stance Rear Legs
- Stability Arm
- Easy To Operate Height Adjustment



MSS3000

MARCHING TENOR STAND

FEATURES

- Stability Arm for a Solid Playing Surface
- Height/Range Adjustable Double-Braced Front Leg
- Oversized No-Slip Rubber Feet
- Wide Open-Stance Rear Legs Allows Standing Room
- Easy To Operate Height Adjustment

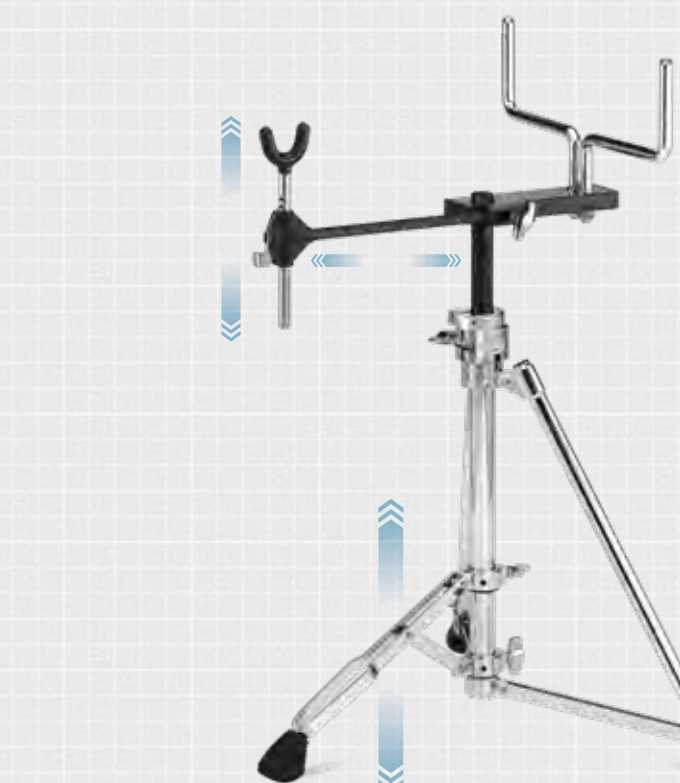
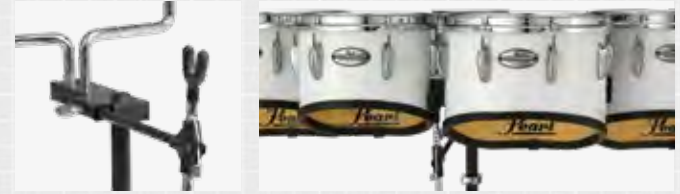

MTS3000

STADIUM FUNCTIONALITY

Pearl Advanced Marching Hardware Snare, Tenor, and Bass Drum Stands include a height/range adjustable front leg to facilitate drumline performances on level ground and in stadium bleachers. The sturdy double-braced front leg adjusts over a 13.5" range on the center post via two ergonomic Ultragrip wing bolts. The leg can be adjusted from a narrow closed position to a high extended position virtually parallel to the ground.

Pearl's MXB1 Marching Bass Drum Stand keeps even the largest tonal bass drums stable and secure. Its 4-arm adjustable basket and extreme range of height adjustment make it a perfect fit with perfect feel for any sized player on any sized drum.

Easy to use - *Rock Solid, any place, any time.*



Pearl's Advanced Marching Snare Stand is designed to deliver Rock Solid Stability and Long-Life Performance from rehearsal, to stadium bleachers, to the field, and everywhere else your playing takes you. The MSS3000 is compatible with CX Airframe and MX T-Frame Carrier Systems and only requires a drum key for adjustment.



The MTS3000 Advanced Marching Tenor Stand provides an optimal experience and feel for Tenor players. The low-profile Stability Arm is easy to use and super strong to keep the drums level and evenly supported no matter how much power the music requires. The MTS3000 is compatible with CX Airframe and MX T-Frame Carrier Systems and requires no tools other than a drum key to make adjustments.



QUICK MOUNT LALO REHEARSAL PAD



PAD35LA
Lalo Davila
Quick Mount
Rehearsal Pad



The PAD35LA mounts on tenors via Pearl's MUH10T Tenor Accessory Mount.



The PAD35LA mounts via the PCS11 Bass Drum Accessory Mount which features a 3/8" knurled rod for multiple mounting configurations.

Designed in collaboration with Pearl Artist and acclaimed percussionist Lalo Davila, the *Lalo Quick Mount Rehearsal Pad* provides a convenient way to practice an excerpt or keep your hands warm. The small, 3.5" diameter pad stows away easily, and mounts to any 3/8" post for convenient positioning. Practice in silence in any environment, from the concert stage to the football field. The Lalo Pad is a great rehearsal tool for marching percussion ensembles, providing the battery with a silent practice option. Get your hands going while the band tunes up, or work out a tricky phrase conveniently and quietly.



The PAD35LA can be used on the concert stage, on your drumset or percussion rig, or anywhere you may want a pad handy.

DRUM CASES & COVERS

DRUM CASES			
14" x 12"	PD1412	24" x 14"	PD2414
14" x 14"	PD1414	26" x 14"	PD2614
16" x 14"	PD1614	28" x 14"	PD2814
18" x 14"	PD1814	30" x 16"	PD3016
20" x 14"	PD2014	32" x 16"	PD3216
22" x 14"	PD2214	Tenor	PD8004

DRUM COVERS			
13"	MDCG13	22"	MDCG22
14"	MDCG14	24"	MDCG24
14"	MDCG14B	26"	MDCG26
16"	MDCG16	28"	MDCG28
18"	MDCG18	30"	MDCG30
20"	MDCG20	32"	MDCG32

TENOR COVERS	
10-12-13-14"	MDCG0234
8-10-12-13" or 8-10-12-14"	MDCG8023

Protect your equipment while in transit or long term storage with Pearl custom-molded cases. Protect your equipment while playing with custom-fit covers.

MARCHING ACCESSORIES & MARCHING SOUND ACCESSORIES



PBL30
Low

PBL20
Medium

PBL10
High

PCB6 / PCB4
6" Bell
4" Bell

PAR100
Anarchy Crasher

PTB60CS
Brazilian Tamborim & Mount



BMH100
Pearl Bass Drum Mallet Holder with Built-in Rim Shooters

BDR1
Bass Drum Rim Shooter

BMH1
Bass Drum Mallet Holder

MUH10
Multi Use Holder

MUH10T
Multi Use Holder

MUH20
FFX Snare Accessory Mount

PCS11
Bass Drum Accessory Mount



SP14B (Matte Black)

SP14W (Matte White)

SP14C (Crystal Clear)

14" Sound Projector with Velcro Tape Mounting
13" Also Available

TS14 Bass Drum Tone Strips
Self adhesive and mounts directly to the bass head for easy muffling



MSB1
Single Stick Bag

MSB2
Double Stick Bag



LR60
Leg Rest



SLG100
Sling



K030
High Tension Drum Key



MDCG24



MDCG14 / MDCG13



MDCG0234 / MDCG8023



PD1412 Snare Case (Fits 13" & 14" Snare Drums)

PD2414 Bass Case

PD8004 Tenor Case (Quad / Quint / Sextet)

Stay Warm between reps, play through the opener a few more times, and work out the sticking on the drum break - and do it without the Band Director yelling at you to "STOP HACKING!"



SR500 TRIAD SILENT STRAINER

At the heart of the World Famous Philharmonic snare drum is the revolutionary SR500 strainer system. The Triad Silent Strainer System provides three individual adjustment knobs allowing you to fine tune the optimum tension for each type of snare material mounted on the drum, and a single global adjustment knob on the butt side for quick overall tension adjustments. An easy to reach single throw lever quickly and silently engages or releases all snare assemblies.

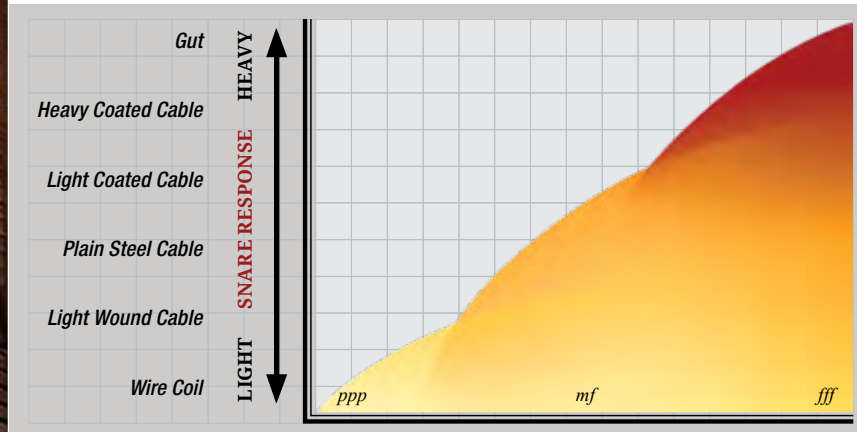

SNARE ASSEMBLY TYPES • The snare assembly material itself can have a major impact on sensitivity, dynamic range, projection and response. In addition, the way the snares are attached and function with the snare throw will equally affect the musicality of the instrument.

PHILHARMONIC SOLID PLY MAPLE

Each PHM Philharmonic Snare Drum is hand-formed from a single ply of fully aged prime Maple to achieve the pinnacle of concert snare drum attack, response, dynamic capability, and tonal color in one instrument. *Truly professional quality. Truly amazing performance.*



PHM1450
#204 High Gloss Walnut Bordeaux

PHM1465
#204 High Gloss Walnut Bordeaux

- FEATURES**
- Solid 7.5mm 100% Maple Shell
 - Die Cast Hoops & Tube Lugs
 - High-Gloss Walnut Bordeaux Finish
 - SR500 Triad Silent Strainer System
 - Graduated Tension Snares
 - Vintage Style Snare Bed
 - Remo Renaissance Heads

- SIZES**
- | | |
|---------|------------|
| PHM1450 | 14" x 5" |
| PHM1465 | 14" x 6.5" |
- *Available in #204 High Gloss Walnut Bordeaux.*

PHILHARMONIC PLY MAPLE

PHP Philharmonic 100% ply Maple shell delivers the power to be heard with dark, full tonal response that has become the preferred sound of orchestras and artists around the world. From the lightest touch to the thickest roll, these drums have the warm response that every player desires.

- | FEATURES | SIZES |
|---|--------------------|
| • 100% Ply Maple Shell | PHP1325 13" x 2.5" |
| • Die Cast Hoops & Tube Lugs | PHP1340 13" x 4" |
| • Single Flange Rims on 13x2.5, 13x4, & 14x4 Drums | PHP1440 14" x 4" |
| • Triad Silent Strainer System | PHP1450 14" x 5" |
| • Graduated Tension Snares | PHP1465 14" x 6.5" |
| • Vintage Style Snare Bed | |
| • Remo Renaissance Heads | |
| <i>* Available in #101 High Gloss Walnut & #103 Piano Black</i> | |
| <i>* 13" x 2.5" Available in #400 White Marine Pearl</i> | |



PHP1325400
#400 White Marine Pearl



PHP1440103
#103 Piano Black



PHP1450101
#101 High Gloss Walnut



PHP1465101
#101 High Gloss Walnut

- | FEATURES | SIZES |
|----------------------------------|--------------------|
| • 1.5mm Brass Shell | PHB1440 14" x 4" |
| • Triad Silent Strainer System | PHB1450 14" x 5" |
| • Graduated Tension Snares | PHB1465 14" x 6.5" |
| • Vintage Style Snare Bed | |
| • Single Flange Rims & Tube Lugs | |
| • Remo Renaissance Heads | |



PHB1440



PHB1450



PHB1465

PHILHARMONIC BEADED BRASS

Pearl's line of Brass Philharmonic drums offers a bright, highly focused, well balanced tone perfect for situations needing more volume and projection. These beautiful drums feature a 1.5mm Black Nickel plated Brass shell.

PHILHARMONIC CAST ALUMINUM

The Philharmonic Cast Aluminum Snare Drum offers a warmth and richness similar to wood, but with the increased brightness and attack characteristic of metal shell snare drums. These incredible

drums represent state-of-the-art design and craftsmanship, allowing the player unprecedented control over the tone, dynamics and performance of the instrument.

- | FEATURES | SIZES |
|----------------------------------|------------------|
| • 3mm Cast Aluminum Shell | PHA1440 14" x 4" |
| • Die Cast Hoops & Tube Lugs | PHA1450 14" x 5" |
| • Single Flange Rims on 14" x 4" | |
| • Triad Silent Strainer System | |
| • Graduated Tension Snares | |
| • Vintage Style Snare Bed | |
| • Remo Renaissance Heads | |



PHA1440



PHA1450



LIMITED LIFETIME WARRANTY

Pearl Concert Drum Shells are guaranteed against material failure, ply separation or going out of round for life. Pearl is proud to be one of the few drum companies in the world to offer a Limited Lifetime Warranty on our drum shells.

PHILHARMONIC AFRICAN MAHOGANY

PHX African Mahogany Concert • The Philharmonic African Mahogany Series Snare and Field Drums add a classic American sound to the existing Philharmonic lineup. Consisting of a 4-ply African Mahogany Shell with 4-ply Maple Reinforcement Rings with Fully Rounded Bearing Edges, these drums provide a dark and throaty sound that will fit with a wide range of musical styles and genres. Wood hoops also come standard on the 15" x 8" and 16" x 16" drums, which combine the emotion and power of traditional rope drums with the technology of the Philharmonic snare system.



PHX1450
#210 Matte Walnut



PHX1465
#210 Matte Walnut



PHX1580
#210 Matte Walnut



PHX1412
#210 Matte Walnut



PHX1616
#210 Matte Walnut

FEATURES

- 4-Ply African Mahogany Shell with 4-ply Maple Reinforcement Rings
- 6 Ply 100% Maple Rims
- 8 Slim-line Chrome Tube Lugs with Insulated Low Profile Chrome Claws
- SR500 Triad Strainer with 2 Synthetic Gut & 1 Heavy Coated Cable Assemblies
- Renaissance Diplomat Batter and Renaissance Snare Side Heads by Remo

SIZES

PHX1450	14" x 5"
PHX1465	14" x 6.5"
PHX1412	14" x 12"
PHX1580	15" x 8"
PHX1616	16" x 16"

* Available in #210 Matte Walnut

PHILHARMONIC SERIES TOMS

Pearl's Philharmonic Series Toms offer the ultimate in uncompromising sound and craftsmanship with their 6 ply African Mahogany shell construction.

Available as single or double-headed versions. The single head version uses our I.S.S. mounting system while the double headed Toms use our state-of-the-art OptiMount System.



PTA Concert Toms with T2000 Tom Stands

FEATURES

- 6 Ply African Mahogany
- 2.3 mm SuperHoop II Rims
- Single or Double Headed Models Available
- OptiMount Mounting System on Double Head Series
- I.S.S. Mounting System on Single Headed Series
- Renaissance Ambassador Heads
- Stands Sold Separately
- Lifetime Warranty

* Available in #210 Matte Walnut Lacquer

SIZES

SIZES Dbl Headed	Sgl Headed	Size
PTA0608D	PTA0608S	6" x 8"
PTA0808D	PTA0808S	8" x 8"
PTA1010D	PTA1010S	10" x 10"
PTA1210D	PTA1210S	12" x 10"
PTA1311D	PTA1311S	13" x 11"
PTA1412D	PTA1412S	14" x 12"
PTA1514D	PTA1514S	15" x 14"
PTA1614D	PTA1614S	16" x 14"



OptiMount

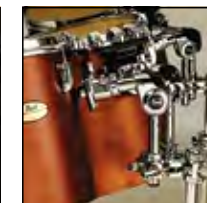

I.S.S. Mount
U.S. Patent #5544561

PHILHARMONIC CONCERT BASS

Philharmonic Concert Bass Drums offer unprecedented bass response. The naturally warm frequency response of the 6 ply African Mahogany shells provide a deep warm resonance ideal for concert use. Strong 2" maple hoops and completely insulated die-cast claws provide optimal tuning with the Silent Tension Lug system. This series of bass drums features Remo Nuskyn® heads designed to promote a dark, warm sound with extended sustain.

FEATURES

- 6 Ply African Mahogany
- Remo Nuskyn® Heads
- Silent Tension System
- Low Mass Lugs
- 12 8mm T-Handle Tuning Bolts
- 2" Wide Maple Hoops
- Lifetime Warranty

* Available in #210 Matte Walnut Lacquer

SIZES

PBA2814	28" x 14"
PBA3216	32" x 16"
PBA3616	36" x 16"
PBA3618	36" x 18"

PBA3216

Shown on STBD32 Stand



Silent Tensioning

Pearl's Silent Tensioning System utilizes low mass quiet lugs and ergonomically designed tuning keys featuring 8mm T-Handle Tuning Bolts for optimal leverage and tuning ease.



SYMPHONIC SNARE DRUMS



SYP1455
#138 Antique Sunburst

SYP1465
#138 Antique Sunburst

Symphonic Snare Drums are a highly versatile instrument for the modern performer. Developed exclusively for the concert hall these drums feature shell construction of 6 ply Maple in a choice of 2 shell depths, 6.5" and 5.5".

The SR300 Multi-Timbre Snare Strainer System functions as 3 individually controlled throw-offs, allowing for 7 snare combinations to fine tune your sound to the music. The Multi-Timbre strainer allows individual control over tension and positioning of each snare strand material stainless, coated cable, and wire.

FEATURES
<ul style="list-style-type: none"> • 6 Ply 7.5mm Maple Shell • Multi-Timbre Snare Strainer • 3 Snare Materials: Coated Cable, Stainless, & Wire • Die Cast Hoops & Tube Lugs • Remo Renaissance Diplomat Heads • Lifetime Warranty

SIZES	
SYP1455 14" x 5.5"	
SYP1465 14" x 6.5"	
* Available in #138 Antique Sunburst	

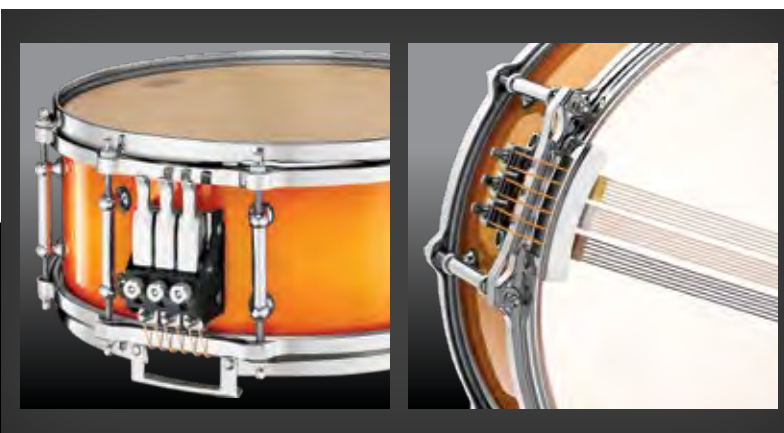

SR300 SNARE STRAINER

The Multi-Timbre Snare Strainer provides quick access to each of the three separately adjustable throw-offs. Each lever controls separate snare assemblies providing seven possible snare combinations. Complete snare tension adjustment is fine tunable via the three individual knobs for a vast range of aural coloring.

SYMPHONIC SERIES TOMS

Today's music requires instruments with power, projection, and fullness of sound. Today's percussionist demands instruments that have a tonal quality that can be used in the studio for the most delicate passages, powerful enough to be heard at the back of the stadium if needed, and durable enough to last on the road. Pearl Symphonic concert toms do all that with the best hardware on the market to back it up.



PTM Concert Toms Single Headed Version

FEATURES
<ul style="list-style-type: none"> • 6 Ply Maple • 2.3 mm SuperHoop II Rims • Single or Double Headed Models Available • OptiMount on Double Headed Toms • I.S.S. Mounting on Single Headed Toms • Renaissance Ambassador Heads • Lifetime Warranty
* Available in #201 Matte Walnut Lacquer Finish

SIZES	Dbl Headed	Sgl Headed	Size
PTM0608D		PTM0608S	6" x 8"
PTM0808D		PTM0808S	8" x 8"
PTM1010D		PTM1010S	10" x 10"
PTM1210D		PTM1210S	12" x 10"
PTM1311D		PTM1311S	13" x 11"
PTM1412D		PTM1412S	14" x 12"
PTM1514D		PTM1514S	15" x 14"
PTM1614D		PTM1614S	16" x 14"

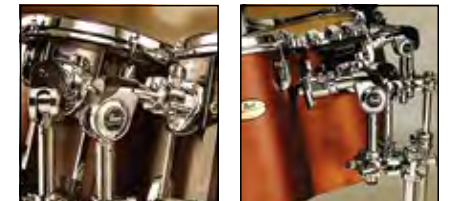

OptiMount

I.S.S. Mount
U.S. Patent #5544561

SYMPHONIC BASS DRUM

Symphonic Series Concert Bass drums provide a solid resounding bass tone with size options that will expand your understanding of what a bass drum can do. 100% Maple shells are the primary material used in concert percussion because of its well balanced tonal response and sustain.



FEATURES
<ul style="list-style-type: none"> • 6 Ply Maple • Silent Tension System • Remo FiberSkyn II Heads • Low Mass Lugs • 12 8mm T-Handle Tuning Bolts • Lifetime Warranty
* Available in #201 Matte Walnut Lacquer Finish

SIZES
PBM2814 28" x 14"
PBM3216 32" x 16"
PBM3218 32" x 18"
PBM3616 36" x 16"
PBM3618 36" x 18"
PBM3620 36" x 20"
PBM3626 36" x 26"

PBM3626
Shown on CBS80M Stand



CONCERT SNARE DRUMS



CRP1455
#102 Natural Maple



CRP1465
#103 Piano Black

Pearl's Concert Snare Drums are packed with high-end features at a price that makes them an outstanding value. Available in 2 sizes, these drums offer many of the features of our flagship models but at a cost any drummer can afford. These drums feature 6 ply all Maple construction, Tube lugs, SuperHoop II rims and Pearl's time proven SR017 strainer that utilizes special Duo-Wire Snares with 7 Strands of Thin Yellow Cable and 7 Strands of Stainless Steel Cable.

FEATURES
• 6 ply Maple Shell Construction
• Vintage Tube Lugs
• SR017 Strainer
• 2 Snare Materials:
7 Strands of Thin Yellow Cable
7 Strands of Stainless Steel Cable
• SuperHoop II Rims
• Remo Renaissance Heads
• Lifetime Warranty

SIZES	
CRP1455 14" x 5.5"	
CRP1465 14" x 6.5"	
* Available in #102 Natural Maple or #103 Piano Black	

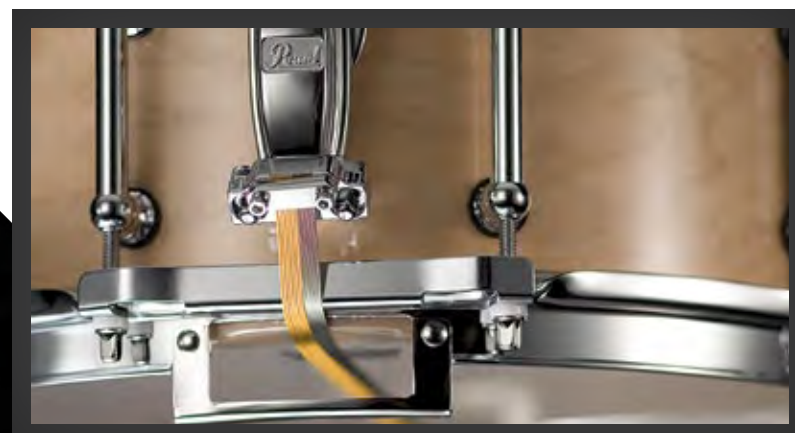

SR017 DUO WIRE

Coated Snare Cable and Stainless Steel Snare Cable are uniquely angle mounted together on a single SR017 Snare Strainer to emulate graduated tension, and to provide both excellent volume and extreme sensitivity while maintaining a constant, full-bodied orchestral snare timbre.

CONCERT SERIES TOMS

Pearl's Concert Series Concert Toms offer a wide range of tuning and performance possibilities. From Concert Hall to Stadium, superb tone and excellent projection can be achieved from our new 6 ply composite shells of durable Poplar and full sounding Kapur cut in full size depths.



PTE Concert Toms

FEATURES
• 6 Ply Poplar / Kapur
• 1.6 mm Steel Hoops
• Available in 4 Sets or 8 Individual Sizes
• Sets include T-890 Double Tom Stand
• Lifetime Warranty
* Available in #46 Midnight Black Covering

SIZES
PTE0608 6" & 8" Toms w/ Dbl Tom Stand
PTE1012 10" & 12" Toms w/ Dbl Tom Stand
PTE1314 13" & 14" Toms w/ Dbl Tom Stand
PTE1516 15" & 16" Toms w/ Dbl Tom Stand



Steel Hoops



T890

CONCERT BASS DRUM

Concert Series Bass Drums have the dynamic projection and extreme volume needed for general concert use, and the perfect choice for field or stadium performances. The PBE shell construction has been upgraded to 6 plies of full sounding Kapur, a hardwood generally reserved for only high end products. Available in 4 sizes and finished in #46 Midnight Black covering with matte black Maple hoops.

FEATURES
• 6 Ply 7.5mm Kapur shells
• Key Bolt Tension Rods
• Steel Claws
• Matte Black Maple Hoops
* Available in #46 Midnight Black Covering

SIZES
PBE2814 28" x 14"
PBE3216 32" x 16"
PBE3616 36" x 16"
PBE3618 36" x 18"



PBE3216
Shown with STBD32 Stand

ACADEMY SERIES XYLOPHONE & MARIMBA

The Academy Series instruments feature a patent pending Integrated Resonator Rail System that provides not only a quality bar suspension and box resonator format, but also the rigid Aluminum Beam structure that makes these instruments the most durable in this class. Academy series keyboards can be used on a table -top, or with the double leg X-style stand. A carry handle is provided to make transport easy and soft cases are available separately. Academy Series keyboards feature the same hand-adjusted bar tuning methods as the top of the line Artist Series instruments and include a pair of mallets and drop cover.



- AMPD30 MARIMBA**
- Padouk bars
 - Octave range: 3.0 C3-C6
 - Easily storable keyboard stand included
 - Built-in carrying handle
 - Box resonator
 - Includes drop cover and 1 pair of MB1 mallets

- AXLD35 XYLOPHONE**
- Light Rosewood bars
 - Octave range: 3.5 F4-C8
 - Easily storable keyboard stand
 - Built-in carrying handle
 - Box resonator
 - Includes drop cover and 1 pair of XB6 mallets

3.3 ACADEMY MARIMBA WITH RESONATORS

Welcome the newest member of the Academy Series of Student Instruments, the all new AMPD33R Padouk Marimba. The AMPD33R features a revolutionary Transverse Resonator System that enhances the tonal performance experience while still allowing the instrument to have the maximum height adjustment for the younger player. The

resonators detach from the Aluminum Rail System of the 3.3 Oct Padouk bar marimba, allowing the instrument to be easily transported or stored. The extended 3.3 oct range of the AMPD33R adds notes down to A2, allowing the player to access a majority of the literature written for the beginner to intermediate player.



- AMPD33R**
- 3.3 octave range, A2-C6
 - Graduated Padouk Bars
 - A=442 Hz
 - High Quality Wooden Bar Instrument at an Affordable Price
 - Transverse Resonator System
 - Durable, Rigid Aluminum Rail Construction
 - Integrated Carry Handle & Height Adjustable X-Stand
 - Includes Drop Cover and One Pair of Mallets

ADAMS ACADEMY SERIES KEYBOARD INSTRUMENTS

The Academy series instruments bring a new level of accessibility and quality to the playing experience of young players. Now everyone can have a high quality wooden bar instrument at an affordable price to maximize the learning experience at an early level.

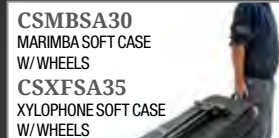

CSMBSA30 MARIMBA SOFT CASE W/WHEELS
CSXFSA35 XYLOPHONE SOFT CASE W/WHEELS
New form fitting padded bags with wheels are now available separately for each Academy model.



The **Xstand** adjusts to 3 playing heights and locks securely into place to safely cradle the instrument.



Aluminum rail construction.
Carry handle.



Transverse Resonator System enhances the tonal performance.



Resonators detach for fold up storage or transportation.



Optimal range of height adjustment to accommodate any size student.

EDUCATIONAL KITS

The perfect start to a career in percussion begins with high quality instruments. Pearl Educational Kits contain superior components that are fast and easy to assemble. The components of each kit store away for easy transport in their own custom made carrying case. The 910 Series Cases have been made more durable with reinforced handles, added pouches, and more compact size.



PL910C

PERCUSSION LEARNING CENTER

PL910C

- 13" x 3.5" Wood Snare Drum
- Wheeled, Rolling Nylon Case
- 2.5 Octave Bells (F5-C8)
- 8" Tunable Practice Pad
- Umbrella Style Bell and Practice Pad Stand
- Includes Snare Basket
- Music Rack
- Bell Mallets
- Snare Drum Sticks
- Retractable Handle



SNARE KIT SK910



Backpack Style Case

SK910

- Backpack Style Case
- 14"x5.5" Steel Snare Drum
- 14" Gladstone Style Practice Pad
- Heavy Duty Snare Stand
- Snare Drum Sticks

SNARE KIT SK910C



SK910C

- Wheeled, Rolling Nylon Case
- 14"x5.5" Steel Snare Drum
- 14" Gladstone Style Practice Pad
- Heavy Duty Snare Stand
- Snare Drum Sticks

PERCUSSION KIT PK910



Backpack Style Case

PK910

- Backpack Style Case
- 2.5 Octave Bells (F5-C8)
- 8" Tunable Practice Pad
- Umbrella Style Bell and Practice Pad Stand
- Music Rack
- Bell Mallets
- Snare Drum Sticks

PERCUSSION KIT PK910C



PK910C

- Wheeled, Rolling Nylon Case
- 2.5 Octave Bells (F5-C8)
- 8" Tunable Practice Pad
- Umbrella Style Bell and Practice Pad Stand
- Music Rack
- Bell Mallets
- Snare Drum Sticks

SNARE STANDS

Our premier S1030 model features Pearl's 360 degree infinitely adjustable GyroLock tilter for ease-of-use and pinpoint positioning. The basket arms adjust to fit snares from 10" to 16" while promoting optimal resonance with Pearl's patented (U.S. Pat. #6710236) Air Suspension Tips.



S1030	S1030L	S1030LS
Basket 10" - 16" Drums	Basket 10" - 16" Drums	Basket 10" - 16" Drums
Tilter GyroLock	Tilter GyroLock	Tilter GyroLock
Arm Tips Air Suspension Rubber Tips	Arm Tips Air Suspension Rubber Tips	Arm Tips Air Suspension Rubber Tips
Legs Double Braced Legs*	Legs Double Braced Legs	Legs Single Braced Legs
Height 18.5" - 25.98"	Height 27.32" - 34.84"	Height 24.61" - 36.42"

*CVT300/3 Spike Feet Ready

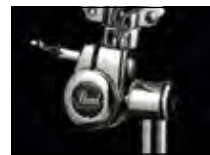

S1030 Snare Stand GyroLock
Infinitely Adjustable Drum Positioning



S1030 Snare Stand Basket
Fits 10" - 16" Snare Drums

The S930 and S930D (with drop basket) offers similar features but uses our legendary Uni-Lock infinitely adjustable tilter.



S930	S930D
Basket 13" - 14" Drums	Basket 13" - 14" Drums
Tilter Uni-Lock	Tilter Uni-Lock
Arm Tips Air Suspension Rubber Tips	Arm Tips Air Suspension Rubber Tips
Legs Double Braced Legs	Legs Double Braced Legs
Height 18.11" - 25.59"	Height 14.57" - 21.65"

TOM STANDS

Pearl's Advanced Hardware offers positioning possibilities never before attainable. Our 1030 Series features our GyroLock tilter for an infinite 360 degree range of movement. The 930 Series use our Uni-Lock tilter for 180 degrees of motion. Our 830 Series use our dependable gear tilter.



T1030 Hinged Collar on the Trident Tripod



T930 Uni-Lock Tom Holders

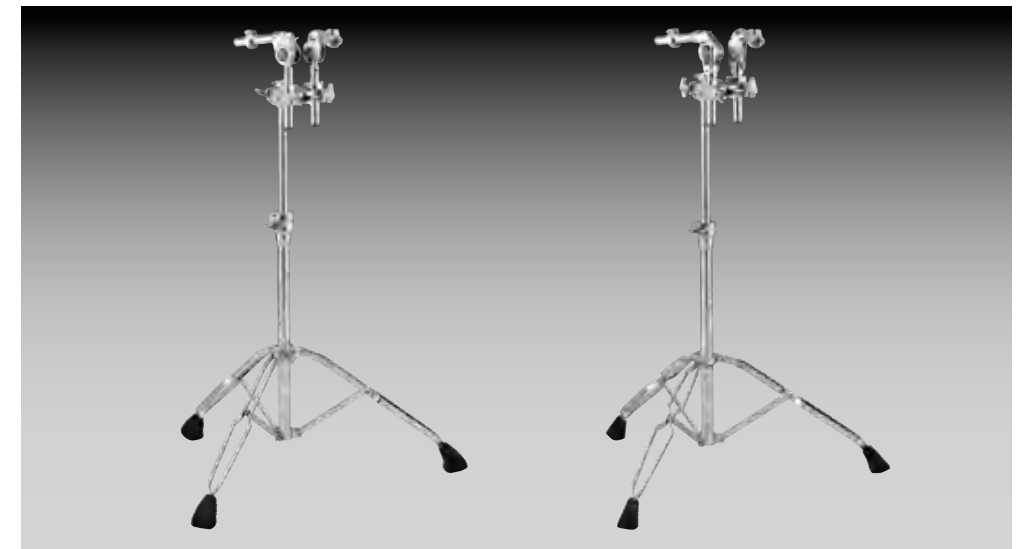

T1030	T930
Tilter GyroLock	Tilter Uni-Lock
Pipe Joint Hinged w/ Stop-Lock	Pipe Joint Hinged
Tubes No Rattle Tubes	Tubes Standard
Fasteners UltraGrip Wingnuts & Wingbolts	Fasteners UltraGrip Wingnuts & Wingbolts
Feet Extra-Large No-Slip	Feet Large No-Slip

CYMBAL STANDS

Pearl is the choice of the serious working drummer. We've been advancing drum hardware since 1946 so if you're serious about drumming, get serious about your hardware. Our C1030 features top-shelf features like a GyroLock tilter, patented (U.S. Patent #7176368) WingLoc Quick Release Wing Nut, patented (U.S. #6940006) Reversible Seat Cup, and Trident Tripod for the ultimate in professional grade performance.

The C930's Clamshell design provides superhuman clamping force. Set your position, lock it down and wail away.

The C830 offers lighter weight while incorporating many of the 1030 series designs. Large, easy-to-use wingnuts and lateral struts ensure optimal stability.



C-1030	C-930	C-830
Cymbal Tilter GyroLock w/ Wing-Loc	Cymbal Tilter Uni-Lock	Cymbal Tilter Uni-Lock
Pipe Joint Hinged	Pipe Joint Hinged	Pipe Joint Direct Pressure
Tripod Hinged Trident Tripod	Tripod Trident-Design Tripod	Tripod Double Braced Tripod
Pipes 1-1/8", 7/8", 5/8"	Pipes 1-1/8", 7/8", 5/8"	Pipes 1", 7/8", 5/8"



DAVE HALL
University of Nebraska - Lincoln



RICHARD WEINER
Cleveland Institute of Music



GENE KOSHINSKI
University of MN Duluth



JONATHAN OVALLE
University of Michigan



PHIL O'BANION
Temple University



ROB KNOPPER
Metropolitan Opera Orchestra



WILLIAM HUDGINS
Boston Symphony Orchestra



JOHN KINZIE
Colorado Symphony



DAVID FISHLOCK
Cincinnati Symphony Orchestra



MICHAEL WERNER
Seattle Symphony



TIMOTHY ADAMS
University of Georgia



JIM ATWOOD
Louisiana Philharmonic



Cynthia Yeh - Chicago Symphony Orchestra

TIMPANI THRONE

Pearl's Timpani Throne provides a new standard of stability and adjustability. Featuring a hydraulic adjustable seat, the throne can be positioned between heights of 23"-33". In combination with the seat, the D3000TC also has an adjustable leg rest to ensure comfort. The throne also has extendable feet that can adapt to uneven floors.



D3000TC

CONCERT CYMBAL STANDS

The C1030SC Goose Neck Cymbal Stand allows the suspension of any cymbal ready for striking. The stand adjusts for height and has single braced legs. The C1030AC Orchestral Cymbal Cradle holds 2 cymbals for quick access. Rubber coated cradles maintain quiet during retrieval and replacement.



C1030SC

C1030AC

BASS STANDS

Pearl offers the most complete selection of Bass Drum Stands on the market. Ranging from an adjustable cradle, to a direct mount, to the professional standard suspended stand, there is a solution for any need.



Third Coast Percussion
DAVID SKIDMORE, PETER MARTIN, ROBERT DILLON, SEAN CONNORS

FOLDING BASS STAND

CBS15

- Lightweight
- Adjustable to Drum Size
- Multi Position Braces
- Rubber Pads on Frame Cross Bars



MULTI-FIT BASS DRUM LEGS

PMBDL3

- Allows Any Sized Wood Hoop Bass Drum to be Played Horizontally
- 3 Height & Angle Adjustable Legs
- Non-Permanent, No-Drill Installation

U.S. Patent #9318084



STBD SUSPENDED BASS STAND

STBD

- Steel Frame Construction
- 360 Degree Angle Adjustment
- Rubber Web Suspension
- Full Length Foot Rest Bar
- Angle Adjustment Locking Handle
- 3" Double Locking Casters
- 4 Sizes (28", 32", 36", 40")

STBD28	28"
STBD32	32"
STBD36	36"
STBD36F	36" w/ Field Wheels
STBD40	40"



Also Available w/ Field Wheels
Pneumatic Double Locking Casters

TILTING BASS STAND

CBS80

- Isolated Suspension Mounting System
- Super Sturdy, Yet Lightweight Tube Frame
- Locking Swivel Adjustment for Drum Angle Positioning
- Four Large Easy Rolling, Lockable Wheels
- CBS80M - for 36"
- CBS80S - for 32"



TILTING BASS STAND

CBS38C

- Gently Cradles Drum on Three Small Rubber Cushions
- Width Adjustable, with Foot Rest
- Angle is Adjustable with the Front Mounting Bracket
- CBS38C Locking Casters



WILLIAM MOERSCH - University of Illinois
MARC DAMOULAKIS - Cleveland Orchestra
JAMES LEE WYATT III - San Francisco Symphony



BRAHAM DEMBAR - Indianapolis Symphony Orchestra
MATTHEW STRAUSS - Houston Symphony
CHRISTOPHER MCLAURIN - Kansas City Symphony Orchestra

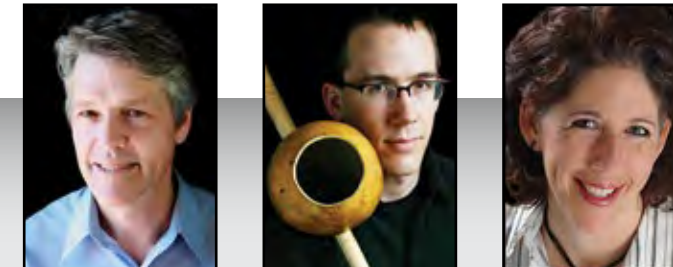

CHRISTOPHER HANNING - West Chester University
GREGORY BEYER - Northern Illinois University
JULIA GAINES - University of Missouri



GARRY KVISTAD, RUSSELL HARTENBERGER, BOB BECKER, BILL CAHN - NEXUS



CAJONS



PCJ629
Jingle Cajon
This Fiberglass cajon features built in Platinela and tambourine jingles that can be engaged for incredible sound with fixed snares.

#629 Carubinga Finish



PBC511M2
Mach 2 Cajon
Made in the USA. The Birch snare section of the faceplate creates a bright response. Walnut bass section provides a punchy low end.

#511 Natural Finish



PCJ633BB
Boom Box Cajon
This Fiberglass cajon with fixed snares features a built-in bass port that magnifies subsonic frequencies for great bass projection.

#633 Artisan Red Mahogany



PCJ633BB630
Boom Box Cajon
This Fiberglass cajon with fixed snares features a built in bass port that magnifies subsonic frequencies for great bass projection.

#630 Red Sparkle



PBC507
Primero Box Cajon
Get started with Primero. Constructed from Asiatic Pine with snares, this model has the right pitch and price.

#507 Gypsy Brown Finish



PCJ633BT
Brush Beat Cajon
This Fiberglass cajon with fixed snares features a built-in bass port and textured surface that responds well when played with brushes.

Black and White Finish

CAJON ACCESSORIES

Enhance your performance by adding dynamic new sounds. Jingle Cups can be added to the face of any Cajon or even to acoustic guitars and other drums. The Cajon Clave and Wood Blocks attach to your cajon using the provided 3M Dual-Lock Tape or can be played hand-held or stand mounted. The Cajon seat cushion adds comfort for long sessions.



CAJH100
Cajon Holster
Nylon w/ Velcro Straps



PSCBC
Seat Cushion
w/ Thick Foam for Comfort

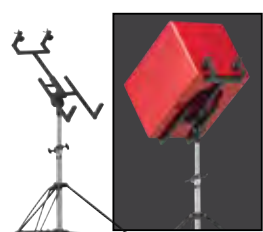

PCJ70STD
Cajon Stand



PJCP1/6
Jingle Cup
Two Pack



PBCW100
Wood Block
w/ Dual-Lock Tape & Mounting Bracket
(PPS37 Not Included)



PBCC100
Clave Block
w/ Dual-Lock Tape & Mounting Bracket
(PPS37 Not Included)

CONGAS, BONGOS, & TIMBALES



Travel Congas
3.5" Deep and Available in Three Sizes: 11", 11.75" & 12.5" • Includes Tuning Wrench • Cases & Stands Sold Separately
PTC1100 11" x 3.5"
PTC1175 11.75" x 3.5"
PTC1250 12.5" x 3.5"



Folkloric Elite Congas
PCW110FC 11" Quinto
PCW117FC 11.75" Tumbadora
PCW125FC 12.5" Tumbadora

HAVANA SERIES



The wide belly shape of these high-end fiberglass drums produce deeper low tones and greater volume. Contour Crown rims and natural skin heads give you clear highs and cutting slaps.

Folkloric Elite Bongos
PBW300FC 7" & 8.5" Bongos
#526 Crimson Sunrise

Havana Congas
PCF110HV651 11" Havana Quinto
PCF117HV651 11.75" Havana Conga
PCF125HV651 12.5" Havana Tumba

Havana Bongos
PBF300HV651 7" & 9" Havana Bongos
#651 Red Tiger Stripe
Also available in #644 Liquid Gold

TIMBALES

Pearl's Primero Pro Steel timbales are a budget conscious timbale set packed with professional features. The heavy-duty braced tilting stand securely supports the 14 & 15-inch steel shells that are 7 inches deep for added projection and greater cascara surface area. The cowbell mount is based off our PT900W Timbale stand making set-up and teardown possible in seconds.



PTS5134
Primero Timbales
13"/14" Steel w/ Tilting Stand
(Stands & Cowbell included)



PTE1415DX
Primero Pro Timbales
14"/15" Steel w/ Tilting Stand
(Sticks included. Cowbell not included)



PBTM1516/C
Banda Series Timbales
15"/16" Steel w/ Tilting Stand
Extra Deep 10" Shells



PTE3131
Flat Timbale w/ I.S.S. (Steel)

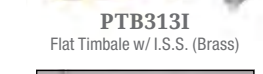

PTB3131
Flat Timbale w/ I.S.S. (Brass)



PTE1336
Primero 13" Steel
w/ PPS36 Mount

BRAZILIAN PERCUSSION



PBS2018
Surdo 20"

PBS1822
Surdo 18"

PBS2222
Surdo 22"

PBS30BD
Legs & BD Adapter Kit for Surdo

PBCX1204
Caixa 12" x 4"

PBCX1265
Caixa 12" x 6.5"

PBC80SS
Caixa

PBT70S
Tamborim Stick

PBSM20
Surdo Mallet



PDZ510
Panzanza
w/ Agogo Bell



PBP510
Pandeiro 10" (5 Sets Platinelas & Goatskin Head) w/ Bag



PBP612
Pandeiro 12" (6 Sets Platinelas & Plastic Head) w/ Bag



PBT60C
Tamborim



PBR10S
Repinique 10"
w/ Strap



PBR12S
Repinique 12"
w/ Strap



HAND & FIELD PERCUSSION



PCL10 Fiber Claves
PMG20 Metal Guiro
PNG20 Natural Gourd Guiro
PGA20 Basket Ganzas (9" x 4")



CBS100 Gatling Cabasa
PBL30 Low (Neon Orange)
PBL20 Medium (Neon Yellow)
PBL10 High (Neon Green)



PTM50BHR (Brass)
PTM50SHR (Steel) Ultra Grip Tambourine
PTM10GH Tambourine w/ Brass Jingles



PGA60FP 21" Field Percussion Shaker
PEC1 Egg Carton
PSK50FC (Uno)
PSK70FC (Caja)
PSK60FC (Segundo)



PFM20 Beaded Maracas
PFM50 Maracabasa
PGA30 (Short)
PGA32 (Long) Hex Ganzas
PGA40 Triple Shaker • Three Sounds in One Shaker
PJH10SH Hi Hat Jingle Ring



WST20FP Field Percussion 10" Shime Daiko
PCF202EDU649 Field Percussion Congas 10" & 11" Congas
PJF350FP649 Field Percussion 14" Fiberglass Djembe Remo NuSkyn Heads

#649 Textured Black designed for outdoor exposure

CONCERT PERCUSSION

Pearl is proud to offer Concert Percussion instruments that are attractively priced for school ensembles, yet engineered with the professional percussionist in mind.



BCM3NY Cha-Cha High
BCM5NY Cha-Cha Low
BCM7NY Mambo
BCM8NYQ Marc Quiñones Signature Timbal
BCM10 Mounted Campana Bell
BCH10 Hand-Held Campana Bell
PCB6 6" Bell
PCB4 4" Bell
ECB23 Mounted Agogo
ECB22 Hand-Held Agogo
PCB1030 10" Bell w/ PPS30



PETM1017 Symphonic Tambourine
PET100 **PET80** **PET60** Elite Triangles
PTC300 Trio Triangle Holder
PTC10 Triangle Clip
PPS12T Stix-Free Triangle Holder
PRT10 Rattler
PCN20S Castanets

TRAP TABLE & RACK



PTT1824 Trap Table 18" x 24"
PTT1824 + PTR1824 Add-On Rack
PTT1212 Trap Table 12" x 12"



PTR1824RC3 Trap Table Single Post Adapter, for PTT1824 & PTT1212

Our popular PTT1824 Trap Table can be easily converted into a two-level folding rack without drilling or modifications by simply adding Pearl's PTR1824 Add-On Rack. The PTR1824 installs in seconds using clamps and folds flush with the table for easy pack-up. A unique clamping system allows the included (4) straight and (4) angled 3/8" knurled posts to clamp anywhere onto horizontal or vertical areas of the rack. Also included is a retractable three-legged stabilizer bar for optimum stability.



So Percussion
 ERIC CHA-BEACH, ADAM SLIWINSKI, JOSH QUILLEN, JASON TREUTING



PCWTB05 Temple Blocks
PCWB100A (High)
PCWB200A (Med.)
PCWB300A (Low)
PSS100 18" Slap Stick



PWCH-3220G 32 Gold Anodized Aluminum Bars With Case, Holder and Striker.
PWCH3220A (not pictured) 32 Anodized Aluminum Bars with Case, Holder and Striker.
PWCH3620A 36 Anodized Aluminum Bars with Case, Holder and Striker.

PERCUSSION CASES

Pearl's padded carrying cases include features like ergonomic carrying straps, rubber protective bottoms, top-mounted carrying handles, tuning wrench pouches, and heavy duty double zippers. The PPB100 is made from heavy weight nylon and will fit all Conga sizes.



PSCBB Bongo Bag
PSC125CG 12.5" Conga Bag
PSC117CG 11.75" Conga Bag
PSC110CG 10" Conga Bag

MIDTOWN

Big Gig, Small Drums, Huge Sound. At home in the class room as well as on stage, Pearl's ultra-portable Midtown Kit is vital for any music program on the go.



MDT764P/C
#704 BLACK CHERRY GLITTER

- Full-size play in a smaller footprint.
- Elevated 16"x14" kick drum delivers solid low-end foundation for solid backbeats.
- Included 10"x7" tom, 13"x12" floor tom, and 13"x5.5" snare create a unique sonic statement.
- Shell pack costs less than many snare drums.



#701 BLACK GOLD SPARKLE #704 BLACK CHERRY GLITTER

DECADE MAPLE

Practice Time is Over, It's Time to Get Serious • To elevate the playing field for today's advancing drummer, Pearl has drawn on 70 years of award-winning drum craftsmanship to create new **Decade Maple** series drums. The first all Maple, lacquered drum set to carry a Lifetime Warranty in this price range, **Decade** is built to push the boundaries of performance and value, and project your drumming voice with authority.

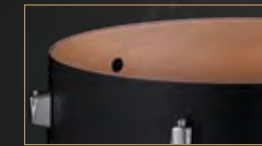

The Kit You've Prepared Yourself for is Here • With feature-heavy shell packs starting at only \$559 Street, Decade Maple drums are perfect as a primary kit for evolving players, or a secondary "gigging" kit for the seasoned pro.

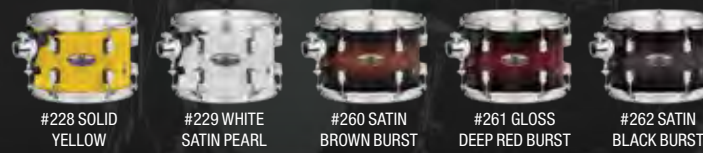
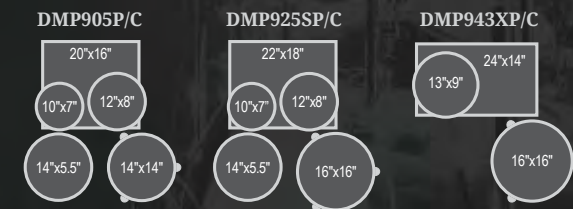

#228 SOLID YELLOW #229 WHITE SATIN PEARL #260 SATIN BROWN BURST #261 GLOSS DEEP RED BURST #262 SATIN BLACK BURST



DMP925SP/C
#260 SATIN BROWN BURST



tune-bot ^{gig} **TUNE LIKE THE PROS!**

- Easily attaches to any standard drum hoop
- New Streamlined Design
- Lug Pitch Measurement
- Overall Pitch Measurement
- Frequency and Note Modes
- Overtone Filters
- Difference Mode

EXPORT



EXX705N/C91
#91 Red Wine

After 30 years of being the #1 Selling drum set in the world, Export Series is still the name every drummer knows. Having jumpstarted thousands of drumming careers by bringing quality and value into one package, today's Export continues to build legends. With features like Reference-inspired shell composition, wrap finishes, and our unbeatable 830 Series hardware package, Export is ready to fuel the fire for future drumming icons.



#21 SMOKEY CHROME #31 JET BLACK #33 PURE WHITE #91 RED WINE #708 GRINDSTONE SPARKLE #717 HIGH VOLTAGE BLUE

ePRO POWERED BY EXPORT



EPEXX725S/C
#708 GRINDSTONE SPARKLE W/ EP02P CYMBALS & EHH2 HI-HAT

The new generation of real electronic drums. ePro Powered by Export is the new generation of electronic drums from Pearl. We have combined the power of ePro Live with our Export series to give you the real look and feel that today's drummer demands. ePro powered by Export is available in both Lacquer and Wrap Finishes and includes the new EHH2 Hi Hat controller.

TRUTrAC ACOUSTIC TO ELECTRIC CONVERSION



Convert any acoustic drum set to an electronic drum set as easy as changing a head with Pearl's Tru-Trac Pack and Tru-Trac Conversion Kits. Tru-Trac Packs are available in two preconfigured kits that include 4 Dual Zone Electronic Drumheads, Electronic Bass Drumhead, 5 No-Drill Adapters that port the cables through the air vents, 5 TRS Cables to connect the drums to the module and extra-long Tension Rods. Tru-Trac Conversion Kits are available in 4 configurations and each includes everything in the Tru-Trac Pack plus a r.e.d.Box Module, Cymbals, Hi-hat Controller, and Holders.

MARCHING PERCUSSION • PAGES 8 - 25

COMPETITOR SERIES			CHAMPIONSHIP MAPLE		CHAMPIONSHIP MAPLE				
	#33 Pure White	#46 Midnight		PLUS All Special Order Lacquers & VARSITY Series Finishes		Covered Standard Finishes	#33 Pure White	#46 Midnight	
CARBONCORE SERIES			VARSITY		SPECIAL ORDER COVERINGS				
	#103 Piano Black					PLUS All Special Order Lacquers and VARSITY Series Finishes (pg. 9)	#91 Red Wine	#92 Aurora Blue	#94 Candy Apple
			VARSITY Series Finishes (pg. 9)						
				#402 Abalone	#406 Bronze Glass	#407 Red Glass	#408 Pewter Glass	#409 Diamond Glitter	

56 SPECIAL ORDER LACQUERS	Marching & Pipe Special Order Lacquers										
										#100 - #818 CarbonCore and Championship Maple Series Only	

ORCHESTRAL PERCUSSION • PAGES 34 - 41

CONCERT SNARE DRUMS									
	#204 High Gloss Walnut Bordeaux (PHM)	#101 Walnut Lacquer (PHP, PHF)	#103 Piano Black (PHP, PHF)	Brushed Aluminum (PHA)	Black Nickel Brass (PHB)	#210 Matte Walnut (Mahogany, PHX)	#138 Antique Sunburst (SYP)	#102 Natural Maple (CRP)	#103 Piano Black (CRP)
CONCERT TOMS				CONCERT BASS DRUMS					
	#210 Matte Walnut (Mahogany, PHA)	#201 Matte Walnut (Maple, PHM)	#46 Midnight Black (PTE)		#210 Matte Walnut (Mahogany, PBA)	#201 Matte Walnut (Maple, PBM)	#46 Midnight Black (PBE)		

PEARL MARCHING & CONCERT CATALOG 2017

Colors shown in this catalog are for representation only and may not be exactly the same as the original due to the printing processes involved.

Products and specifications are subject to change without notice.
Printed in USA MCC2017



WWW.PEARLDRUM.COM

	pearldrumsfan		PearlDrumCorp
	PearlDrumCorp		pearl_drums