

1946

75 *Pearl*[®]
CELEBRATING
SEVENTY-FIVE
YEARS

2021



2021 GENERAL CATALOG



PRESIDENT SERIES PHENOLIC

A Diamond Jubilee Edition reissue of one of Pearl's most iconic and celebrated drum sets.

SHELL RECIPE: Hermetically Pressurized 4.5mm Phenolic.
SOUND: Loud, distinctive resonance with tonally articulate decay.
p. 4 - 5



PRESIDENT SERIES DELUXE

The original "MIJ" sound returns for a darkly traditional, controlled playing experience.

SHELL RECIPE: 6-ply, 7.5mm Lauan.
SOUND: Subdued and centered with singular low-range overtone.
p. 6 - 7



MASTERWORKS

A custom tailored heirloom instrument for the drummer who wants ultimate control.

SHELL RECIPE: Choice/Combination of Birch, Maple, Gum, and/or Mahogany.
SOUND: Any desired sound is possible; you decide!
p. 8 - 13



SESSION STUDIO SELECT

Radically unique from Stage to Studio, blending pre-EQ'd warmth and articulate punch.

SHELL RECIPE: EvenPly-Six Birch (4-ply outer), African Mahogany (2-ply inner).
SOUND: Deep, rich bass frequencies. Top-end tonal spike.
p. 30 - 31



CRYSTAL BEAT

The original seamless Acrylic drum shell creates a striking visual and sonic showcase.

SHELL RECIPE: 7mm Seamless Molded Acrylic.
SOUND: Loud and immediate, delivers pummeling straight tone and yielding feel.
p. 32 - 33



REFERENCE

Individually engineered with premium Masterworks materials for articulate power and projection.

SHELL RECIPE: Reference Recipe Birch, Maple, and Mahogany hybrid.
SOUND: Enhanced output, cutting highs, powerful lows.
p. 14 - 15



REFERENCE PURE

Reference Recipe shell engineering in a lighter format for increased body and sustain.

SHELL RECIPE: EvenPly Birch, Maple, and Mahogany hybrid.
SOUND: Expressive, open tonality with responsive bottom-end boost.
p. 16 - 17



MUSIC CITY CUSTOM

Hand assembled in the USA for true Pearl Artists... Like you.

SHELL RECIPE: Choose From Four Premium SST Shell/Hardware Recipes.
SOUND: RF vast projection, RFP near field vibe, MRV classic tones, or MMG studio proven sound.
p. 18 - 23



DECADE MAPLE

Premium gear for the evolving drummer, featuring lacquered, all Maple shells and pro level elements.

SHELL RECIPE: EvenPly-Six, 5.4mm Maple.
SOUND: Full Maple tone with lively midrange and smooth sustain.
p. 34 - 35



EXPORT / EXPORT LACQUER

The Best Selling Drum Set of All Time gives the student drummer a strong beginning.

SHELL RECIPE: 6-Ply 7.5mm Poplar/Asian Mahogany Blend
SOUND: Crisp attack with dark, formidable bottom-end vibrance.
p. 36 - 37



MASTERS MAPLE RESERVE

The vintage flair of the original Masters sound for a refined playing experience.

SHELL RECIPE: 4-ply Maple w/ 4-ply Reinforcement Rings.
SOUND: Balance of powerful midrange and smooth resonant attack.
p. 24 - 25



MASTERS MAPLE GUM

Vital, recording optimized tone derived from the Masterworks: Studio shell recipe.

SHELL RECIPE: EvenPly-Six Maple (4-ply outer) and Gum (2-ply inner).
SOUND: Explosive midrange, full low-end, precise decay.
p. 26 - 27



MASTERS MAPLE COMPLETE

A road ready sonic powerhouse with inspired custom appointments.

SHELL RECIPE: EvenPly-Six, 5.4mm North American Maple.
SOUND: Booming projection with equalized Low/Mid/High frequency mix.
p. 28 - 29



MIDTOWN

An ultra portable shell pack for full sized play and powerful grooves in a small footprint.

SHELL RECIPE: 6-ply 7.5mm Poplar.
SOUND: Tight, responsive tonal bite with enough bottom to fill the pocket.
p. 38



ROADSHOW

A drum set package complete with everything needed to kickstart your rhythmic journey.

SHELL RECIPE: 9-ply 7mm Poplar.
SOUND: Piercing, open cut with full sub-bass rumble.
p. 39

DRUM SETS

- 4-7 President Series
- 8-13 Masterworks
- 14-15 Reference
- 16-17 Reference Pure
- 18-23 Music City Custom
- 24-25 Masters Maple Reserve
- 26-27 Masters Maple Gum
- 28-29 Masters Maple Complete
- 30-31 Session Studio Select
- 32-33 Crystal Beat
- 34-35 Decade Maple
- 36-37 Export / Lacquer
- 38 Midtown
- 38 Rocket Toms / Compact Traveler
- 39 Roadshow / Jr.

ELECTRONIC SERIES

- 40-41 e/MERGE
- 42 MIMIC PRO
- 43 malletSTATION

SNARE DRUMS

- 44-45 MCC Solid Shell
- 46-47 President Series
- 46-47 Reference
- 48 Series Component
- 49 Free Floating
- 50 SensiTone Heritage Alloy
- 51 SensiTone Premium
- 52-53 Signature
- 54 Hybrid Exotic
- 55 DuoLuxe
- 55 StaveCraft
- 56 Modern Utility
- 57 Utility & Effects

HARDWARE

- 58-59 Demon Drive / Chain
- 60-61 Eliminator Redline
- 62-63 Eliminator Solo
- 64-65 P930 / P932
- 65 P530 / P830
- 66-67 Hi-Hat Stands
- 68 Snare Stands
- 69 Drum Thrones
- 70-71 Cymbal Stands
- 72-74 Racks / Accessories
- 75 Tom Stands / Arms

PERCUSSION

- 76 Percussion Artists
- 77 Signature Series
- 78-79 Congas & Bongos
- 80 Travel Congas, Bongos, Timbales
- 81 Timbales / Cowbells
- 82 Djembes
- 83 Folkloric / Brazilian
- 84-85 Cajons & Accessories
- 85 Tongue Drums
- 86 Rainsticks / Nut Shakers
- 87 Concert Percussion
- 88-89 Hand Percussion
- 90 Percussion Stands
- 91 Bags, & Holders

- 92-94 Replacement Parts
- 96-99 Pearl Artists
- 100-BACK Config. & Color Chart

PEARL BY THE NUMBERS

75TH ANNIVERSARY EDITION



4/2/1946

The day Katsumi Yanagisawa founded Pearl with two employees in a 300 sq. ft. factory in Sumida, Japan.



93

The total number of countries worldwide where Pearl products are sold.



#1

Export, the number one selling drumset of all time. (pg. 36-37)



1,000,000

Pearl sold its one-millionth Export drum in 1995.

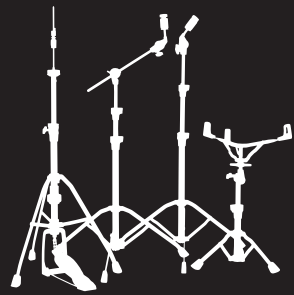

570

Number of tons of zinc used each year to make Pearl hardware.

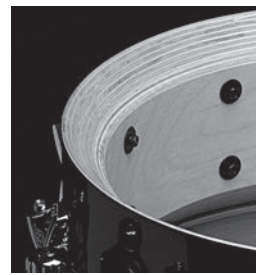

25

25mm - The thickness of a Pearl 20 ply Reference Series snare drum.



234

The total number of snare drum models offered by Pearl worldwide. (pg. 44-57)



8

Individual patents on the Eliminator bass drum pedal. (pg. 60-61)



658

The number of drum finishes Pearl has offered over the last two decades.



51 Reference

The number of steps in the painting process for Pearl Reference Series Sparkle finishes. (pg. 14-15)

1989

The year Pearl introduced the slogan, **The best reason to play drums.**

9042

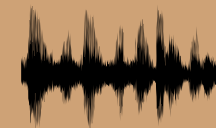

Average number of drum and cymbal samples used in a single kit in Mimic Pro.



66,972

Number of drum samples in the Mimic Pro module. (pg. 42)

200°F

Pearl's Superior Shell Technology cooks the glue into the shell at a temperature of 200 degrees.

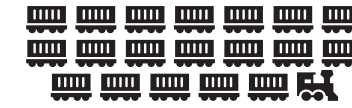

1130

The number of cubic meters of sustainable wood used each year by Pearl to build drums would fill 19 train cars.



17,712

With Commander James Wetherbee, this Pearl drum key traveled at a max speed of 17,712 MPH and reached a maximum altitude of 244 miles aboard the U.S. Space Shuttle ATLANTIS in September 1997.

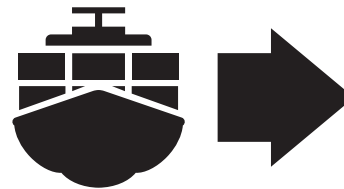

1,879,531

The total number of miles (in an average year) Pearl Drums travel by truck, train, and ship from our factories to Nashville.

1983

The year the Garfield Cadets, under the percussion direction of Thom Hannum, scored the only perfect drum score in the history of DCI.



37,691

The total number of products available from all Pearl factories.

3/22/2007



The day Pearl joined social media, leading to over 1.6 million followers across all Pearl profiles today.



249,194,880,000

The number of possible Masterworks recipes based on current options. (pg. 8-13)

75 Pearl

CELEBRATING SEVENTY-FIVE YEARS

75 YEARS

900 MONTHS

27,394 DAYS

657,456 HOURS

39,447,360 SECONDS



...Devoted to Total Customer Satisfaction

PRESIDENT SERIES PHENOLIC

A TRULY HISTORIC ORIGINAL WITH IMMACULATE VINTAGE STYLE

CERTIFICATE OF AUTHENTICITY INCLUDED

Each President Series Phenolic drum kit comes standard with a numbered 75th Anniversary Edition 14"x5.5" snare drum and Certificate of Authenticity.

75 *Pearl*
CELEBRATING
SEVENTY-FIVE
YEARS



Few "vintage" instruments have the rare presence of Pearl's original professional drum set: the President Series. Introduced in 1966, President Series was the first drum set to utilize the unique benefits of hermetically pressurized Phenolic shells.

In celebration of Pearl's history of quality and craftsmanship, President Series Phenolic shells make a triumphant return in a Limited Edition, 75th Anniversary drum set. Exuding pristine vintage style with focused updated function, President

Series Phenolic drums feature the tonal articulation and feel of the original with a modern-classic retool.

Special appointments include our original "Battleship" lug, adjustable internal tone mufflers, classic felt bass drum muffling strip, bass drum shell-mounted cymbal holder, and adjustable "Gullwing" style bass drum spurs. Pearl's elegant script badge and classic bass drum logo add to its old school swagger.

PRESIDENT SERIES PHENOLIC KIT
IN #452 PEARL WHITE OYSTER

SHELL	Phenolic BD: 4.5mm, TT/FT/SD: 4mm
SNARE	14" x 5.5" (included)
FINISH	#452 Pearl White Oyster
HEADS	Remo USA Coated Ambassador Top/ Bottom, Anniversary Ed. Smooth White Coated Ambassador w/ Classic Pearl Logo
SPURS	BSP835 "Gullwing" Style
BD CYMBAL MOUNT	CHB75LB
HOOPS	SuperHoop II 2.3mm Triple-Flanged
LUGS	BSL100/BSL200/BSL55
BD MUFFLER	BDMF and Resonant Felt Strip

SHELLS

Hermetically Pressurized (4.5mm) Phenolic. A uniquely thin, thermo-layered solid shell that projects with uniquely cutting clarity from the strike, decaying quickly with even midrange spread.



BEARING EDGE

Rounded 45° - Increased head-to-shell contact boosts mids and highs and helps control overtone spread.



HARDWARE

2.3mm SuperHoop II Hoops - Made to maintain tuning integrity in heavy play while delivering maximum shell resonance.



BSL LUGS

Cast in 1969 as "C043" for Pearl's professional outfits, it has since been dubbed "The Battleship Lug" by collectors for its angular profile. The new BSL100 features the same striking look and self-aligning design with a more robust casting for better tuning integrity.

FIBER CASE INCLUDED

Finally, true to the drum sets of the era, each drum comes factory direct in its own Pearl fiber case.



PRESIDENT SERIES DELUXE

A MODERN REVIVAL OF THE DARKLY UNIQUE LAUAN SOUND



PRESIDENT SERIES DELUXE KIT
IN #767 OCEAN RIPPLE
PSD903XP/C767



PRESIDENT SERIES DELUXE KIT
IN #768 DESERT RIPPLE
PSD923XP/C768

PEARL

A modern take on a familiar favorite, President Series Deluxe drums revive our original 6-ply Lauan shell, the source of the original "MIJ" (Made in Japan) sound. This darker toned medium/hardwood was the basis of thousands of shells made by Mitsuo Yanagisawa in Pearl's Chiba, Japan-based drum factory starting in 1961.

Presenting prime vintage style without the shortcomings of yesterday's fittings, President Series Deluxe features a recasting of our classic "Battleship" lug

and adjustable tone mufflers on each drum. The elegant identity of Pearl's original script badge and classic bass drum logo augment the swirling flash of a choice of our new Ripple covered finishes.

Each President Series Deluxe drum kit comes standard with Remo CS "Black Dot" UT heads, classic felt bass drum muffling strip, shell-mounted cymbal holder, and adjustable "Gullwing" style bass drum spurs.

SHELL	6-ply 7.5mm Lauan
SNARE	14" x 5.5" (Sold Separately)
FINISH	Premium USA Ripple Coverings
HEADS	Remo UT CS Black Dot Batters Anniversary Ed. Smooth White Coated Ambassador w/ classic Pearl Logo
SPURS	BSP835 "Gullwing" Style
BD CYMBAL MOUNT	CHB75LB
HOOPS	SuperHoop II 2.3mm Triple-Flanged
LUGS	BSL100/BSL200/BSL55
BD MUFLER	BDMF and Resonant Felt Strip

Drawing from the very origins of Pearl's drum manufacturing history, President Deluxe Series revives the warm subtlety of our original tone wood for a traditionally full, controlled playing experience.



SHELLS

6-ply 7.5mm Lauan. Loud yet subdued with deep, punchy wallop and plenty of top-end attack.

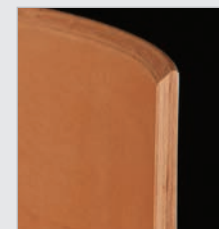

BEARING EDGE

Rounded 45° - Increased head-to-shell contact boosts mids and highs and helps control overtone spread.



HARDWARE

2.3mm SuperHoop II Hoops - Made to maintain tuning integrity in heavy play while delivering maximum shell resonance.



BSL LUGS

Cast in 1969 as "C043" for Pearl's professional outfits, it has since been dubbed "The Battleship Lug" by collectors for its angular profile. The new BSL100 features the same striking look and self-aligning design with a more robust casting for better tuning integrity.

MASTERWORKS

COMPLETELY CUSTOM, TOTALLY HANDMADE

HANDCRAFTED TO INSPIRE

A Masterworks drum set is a timeless expression; custom tailored with heirloom precision to elevate your drumming persona, and fully reflect your musical identity.

DRUMMING WITHOUT LIMITS

Selecting the right combination of our finest hand selected shell veneers with the precision engineering of our premium hardware appointments, Masterworks gives you the freedom to customize a sound that is completely your own.



MASTERWORKS CUSTOM KIT IN GLOSS NATURAL ARTISAN SYCAMORE FINISH W/EBONY INLAY AND BLACK NICKEL-PLATED HARDWARE

DRUM SHELL TONE WOODS

Each of our premium shell materials has its own sonic signature that greatly affects the overall sound of each drum.



- MAPLE**
The perfect blend of tone, attack, and body.
Equal tonal amounts of highs, mids, and lows.
- BIRCH**
"Built-in EQ" delivers articulate stroke with shorter, even decay.
Boosted highs and mellow mid-level tone.
- AFRICAN MAHOGANY**
Deep, powerful punch with dark, elegant tone.
Bottom end emphasis with beautifully smooth midrange sustain.
- GUMWOOD**
Explosive projection and increased volume.
As a core or interior ply, Gum enhances tone in surrounding plies.
- CUSTOM INTERIOR**
The Ultimate Hybrid.
Choose any of Pearl's Artisan Exotic exterior hardwoods, hand applied carbon fiber, or a thin layer fiberglass for boutique tones and visuals.

SHELL SIZE AND THICKNESS

For precise tonal character, sustain, and projection.

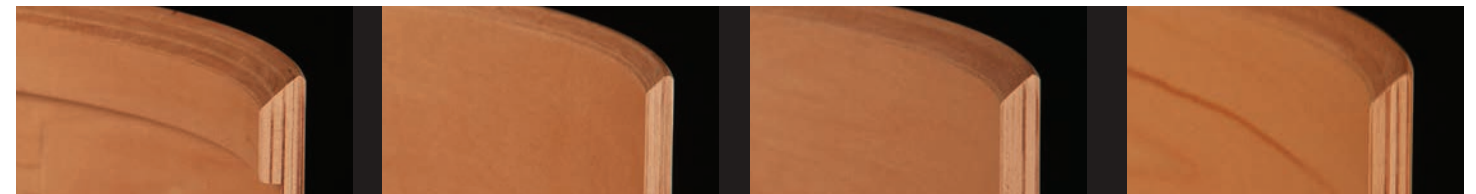

- THIN (4-ply, 5mm w/4-ply Reinforcement Rings)** Increased sustain and low-end.
- MEDIUM (EvenPly-6, 5.4mm)** Expanded tonal purity and resonant punch.
- STANDARD (6-ply, 7.5mm)** Full-bodied tonal projection ideal for general purpose.
- THICK (8-ply, 10mm and 10-ply, 12.5mm)** Maximum projection and quick decay.

FINISHES

CRAFT a personalized visual statement with drums hand finished and configured to your specifications.

LUXURY - Includes a choice of High Gloss, Satin Stain, and Sparkle Lacquer.
CUSTOM - Includes Pinstriping, Banding, Artisan II Custom Graphics.
ARTISAN - Choose from a selection of Exotic veneers (below) or hand applied Carbonply.

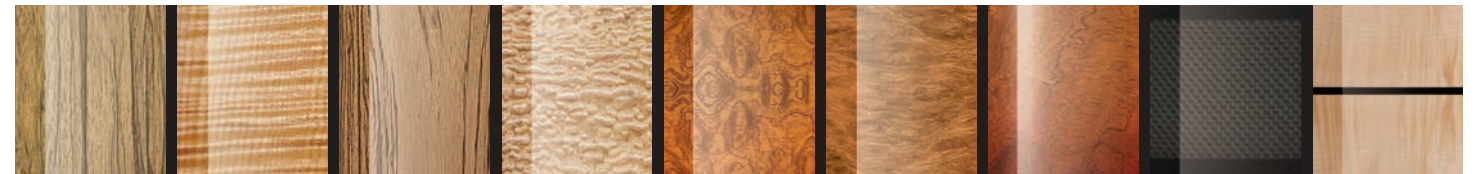

- CAMEROON BLACK LIMBA
- FLAME MAPLE
- AFRICAN ZEBRAWOOD
- TAMO ASH
- WATERFALL BUBINGA
- EUCALYPTUS
- BURL MAHOGANY
- CARBONPLY
- SYCAMORE w/ EBONY INLAY

BEARING EDGE

Masterworks offers a choice of five sonically tested edges - configurable by drum, application, and shell side.



- STANDARD 45°**
Provides the perfect blend of attack and warmth.
- OUTER 60°**
Pulls brighter overtones and increases punch.
- INNER 45°** Edge apex focused to inner shell plies for controlled sustain.
- ROUNDED 45°** Increased head-to-shell contact boosts mids and highs.
- FULLY ROUNDED**
Boosts mid-to-low range response and reduces decay.

Choose from five gorgeous plating options on your selection of our precision tuning lugs, hoops, and drum hardware.

HARDWARE FINISH, LUG, AND HOOP OPTIONS

LUGS

- Bridge (CL100)
- Single Swivel (STL100)
- Swivel Tube (STL150)
- Swivel Arch (BRL100)

FINISHES

- CHROME** (Shown w/ CL100 Lug)
- NICKEL** (Shown w/ STL100 Lug)
- GOLD** (Shown w/ STL150 Lug)
- BLACK CHROME** (Shown w/ BRL100 Lug)
- BLACK NICKEL** (Shown w/ STL150 Lug)

HOOPS

- MASTERCAST DIE-CAST**
- 2.3MM SUPERHOOP II**
- FATTONE**

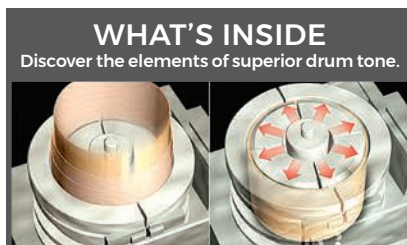

THE **EST** DIFFERENCE - The Ultimate in Strength, Resonance, and Tone.
Superior Shell Technology

Using the world's first high temperature hydraulic curing system, the SST method was developed to craft a multi-ply, bonded drum shell with single-ply resonance and strength.

All shells are formed in a bonded combination of cross-laminated 2-ply veneer panels; precision milled with overlapping scarf joint seams and cured with our exclusive AcoustiGlue at 1000 PSI of hydraulic pressure.

MASTERWORKS

SONIC-SELECT SHELL RECIPES



THE MASTERWORKS EVOLUTION CLEARLY DEFINED BY PERFORMANCE APPLICATION.

Five distinct drum recipes; each one a combination of sonically proven shell woods, edge profiles, and precision hardware options. Crafted to create a truly unique tonal signature.

URBAN (pgs. 10 - 11)

A thin, powerful blend for the precise metropolitan drummer.

STADIUM (pg. 12)

Pearl's thick CZX Maple shell for high-volume power.

STUDIO (pg. 12)

Explosive tonal clarity and articulation for recording.

HERITAGE (pg. 13)

Classic drum feel with enhanced lows and fat top-end slap.

MODERN DRY (pg. 13)

Quick, top-heavy articulation with controlled low-end.



SHELL	EvenPly-Six (5.4mm Toms/Bass) 2-Birch/2-Gumwood/2-Birch with 4-ply Maple Re-Rings 8-ply Snare Drums 2-Birch/4-Gumwood/2-Birch
BEARING EDGE	Rounded 45° on Toms Fully Rounded edge on bass drums Standard 45° on snare drums
HOOPS	2.3mm SuperHoop II
LUGS	STL Swivel Tube Lugs STL150 (Toms) STL300 (Bass Drum)
SPURS	SP300 w/ Retractable Spike
FLOOR TOM BRACKETS	LB200

Masterworks Sonic-Select Urban Recipe

A NEW BREED OF HIGH END DRUMS FOR THE METROPOLITAN PLAYER.

From sold out tours to sanctuary halls, the Sonic-Select Urban formula projects with a defiant top end and fills the bass frequencies with thunderous, shaking lows.

MASTERWORKS SONIC SELECT URBAN KIT IN GLOSS BLACKBURST ARTISAN SYCAMORE FINISH WITH BLACK NICKEL-PLATED HARDWARE (configured w/ MASTERCASHT HOOPS)



SHELL
Dense, thin shell hybrid for precise punch and quick, even decay.



BEARING EDGE
Rounded 45° on Toms (Fully Rounded edge on bass drums, Standard 45° on snare drums)



HARDWARE
2.3mm SuperHoop II Hoops - Made for heavy play without limiting tuning range performance.

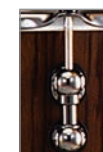

LUGS
A medium-weight lug with pivoting tension casing for increased projection and reduced overtone. STL150 / 300

Masterworks Sonic-Select Stadium Recipe



MASTERWORKS SONIC SELECT STADIUM KIT IN GLOSS WHITE GOLD DUST LACQUER FINISH WITH GOLD-PLATED HARDWARE (configured w/ FAT TONE HOOPS)

THE CZX SOLUTION FOR HIGH VOLUME, RHYTHMIC COMMAND.

This high density shell and hardware recipe is a modern interpretation of Pearl's legendary CZX (or Zenithal Resonator) Maple shell. Stadium's thick shell for dominates volume and articulates attack. Its 10-ply/8-ply combination projects with full bodied midrange and focused low end.

SHELL	10-ply Maple BD, 10-ply Maple FT, 8-ply Maple Toms and Snares
BEARING EDGE	Outer 60° For increased power and controlled overtone
HOOPS	2.3mm SuperHoop II
LUGS	Swivel Bridge Lugs to maintain attack and tuning integrity. BRL100 (Toms) BRL300 (BD)
SPURS	SP300 w/ Retractable Spike
FLOOR TOM BRACKETS	LB200



SHELL
A thick shell for dominating volume and articulate attack.



BEARING EDGE
Outer 60° Increases brightness and power with controlled overtone.



HOOPS
2.3mm SuperHoop II Hoops - Made to withstand heavy play while allowing the shell to breathe.



LUGS
Heavier weight increases attack and assures the ultimate in tuning integrity.

Masterworks Sonic-Select Studio Recipe



MASTERWORKS SONIC-SELECT STUDIO KIT IN TRANSPARENT PRUSSIAN BLUEBURST OVER ARTISAN FLAME MAPLE WITH NATURAL STRIPE AND NICKEL PLATED HARDWARE

A POWERFUL SONIC FOUNDATION TUNED FOR THE RECORDING ENVIRONMENT.

The Studio Recipe's commanding hardware/shell combination delivers explosive projection in the midrange for clean tonality and extended low end punch. Its thin, historically proven shell combination of a hard exterior with milder tonewood crafts explosive low range warmth.

SHELL	EvenPly-6 (5.4mm), 4-ply Maple Outer with 2-ply Gumwood Inner
BEARING EDGE	Outer 60° Gives increased power and bite to a thinner hybrid shell
HOOPS	MasterCast Hoops
LUGS	CL Bridge Lug CL100 (Toms) CL250 (Bass Drum)
SPURS	SP300 w/ Retractable Spike
FLOOR TOM BRACKETS	LB200



SHELL
Thin, resonant combination of a hard exterior with milder tonewood for explosive low-range warmth.



BEARING EDGE
Outer 60° Gives increased power and bite to a thinner hybrid shell.



HOOPS
MasterCast Hoops. Escalates weight for tonal body Increases volume in high velocity play.



LUGS
CL Bridge Lug A classic look with minimal shell contact for precise vibration control.



MAKE MASTERWORKS COMPLETELY YOUR OWN

Turning the drum kit into a blank canvas, Masterworks Sonic Select Shell Recipes can be customized to fit your own vision. Modify any shell or hardware option to give it your own spin, or use our exclusive Artisan II process to embed your choice of high-def graphics directly onto the outer shell.

Masterworks Sonic-Select Heritage Recipe



MASTERWORKS SONIC-SELECT RECIPE: HERITAGE KIT IN SATIN OLIVEBURST LACQUER WITH A2 ROSARY BANDS (BY ILLUSTRATOR JESSICA HANCOCK) AND NICKEL-PLATED HARDWARE

ORGANIC TONE THAT PURRS LIKE THE GROWL OF A CLASSIC ROADSTER.

The Sonic-Select Heritage Recipe's traditional blend of reinforced Maple/Mahogany delivers a midrange punch with solid low end boost. This robust combination produces thunderous sub bass frequencies with exceptional sustain and subtle projection.

SHELL	4-ply Maple (2-ply outer) Mahogany (2-ply inner) w/ 4-ply Maple Re-Rings
BEARING EDGE	Standard 45° Low contact edge for added projection and resonance.
HOOPS	1.6mm FatTone
LUGS	STL100 (Toms) STL200 (Bass Drum)
SPURS	SP300 w/ Retractable Spike
FLOOR TOM BRACKETS	LB200



SHELL
A traditional blend of midrange punch and boosted low-end.



BEARING EDGE
Standard 45° - Precise, low-contact edge for added projection and resonance.



HARDWARE
FatTone Hoops - The light, rigid design of its exclusive hemmed edge increases resonance and tuning stability.



LUGS
Our lightest and most efficient tuning lug reduces hardware contact and weight on the shell.

Masterworks Sonic-Select Modern Dry Recipe



MASTERWORKS SONIC SELECT MODERN DRY KIT IN KOBALT BLUE FADE METALLIC LACQUER FINISH WITH BLACK NICKEL-PLATED HARDWARE

DARKLY ORGANIC PUNCH FOR DRIVING, ORGANIC BEAT MAKING.

The Modern Dry Recipe blends three sonically unique tone woods for dark, controlled tone, and pillowy response. Its unique blend of shell and hardware elements adds bottom end focus and throaty punch.

SHELL	2-ply Maple outer/2-ply Gumwood inner with 4 ply Mahogany Re-Rings
BEARING EDGE	Inner 45°
HOOPS	MasterCast Hoops
LUGS	Single Swivel Lugs STL100 (Toms) STL200 (BD)
SPURS	SP300 w/ Retractable Spike
FLOOR TOM BRACKETS	LB200

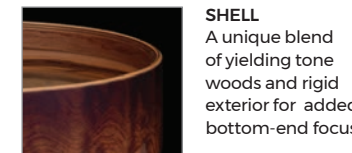

SHELL
A unique blend of yielding tone woods and rigid exterior for added bottom-end focus.

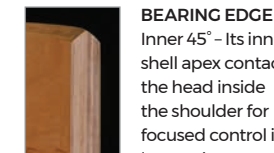

BEARING EDGE
Inner 45° - Its inner shell apex contacts the head inside the shoulder for focused control in low tunings.



HOOPS
MasterCast Hoops - Gives each drum added weight for increased volume and controlled sustain.



LUGS
Single Swivel Lugs Our lightest and most efficient tuning lug for reduced shell contact. STL100/200

REFERENCE

SONICALLY SELECT DRUM PERFORMANCE

Reference

SONICALLY PROVEN SHELL PERFORMANCE

Utilizing the nearly limitless selection of materials and options from our Masterworks Custom Shop, each Reference tom, snare, and bass drum is individually-optimized with its own shell, hardware, and edge "Recipe" to best capture its intended voice.

Just as single notes combine to make a piano, the total Reference kit's singular, unified voice perfectly captures every nuance of your unique drumming ideal.



#839 Redburst Triband



#832 Sapphire Blue Sparkle
RF924XSP/BN**

SHELL	Maple, Birch & African Mahogany
SNARE	20 Ply Matching 13 x 6.5, 14 x 5 or 14 x 6.5"
FINISH	Super High Gloss Lacquer / Lacquer Sparkles
HEADS	Remo Clear Emperor Tom, Powerstroke3 Bass
TOM MOUNTS	Aluminum OptiMount Suspension System
TOM ARMS	Sold Separately
HARDWARE	Chrome (Standard) Nickel, Black Nickel, and Gold**
HOOPS	MasterCast Die-Cast Hoops
LUGS	BRL Bridge Lugs with Swivel Function

SHELLS

Individually engineered for power, tone, and distinction, the total Reference kit perfectly captures every nuance of your unique drumming identity with a singular, prestigious sound.



HARDWARE

MASTERCAST HOOPS enhance the overall weight and volume of each shell and stay true under constant play.

BRL SWIVEL LUGS feature pivoting internal brass tension casings to assure tuning integrity and reduce shell stress.



SP300 SPUR

Pearl's SP300 bass drum spur features retractable high grip rubber tip and recessed spike for high impact, slip free play.

REFERENCE RECIPE

8" and 10" Toms	
12" Toms	
13" Toms	
14" and 15" Toms	
16" Toms	
14" Floor Toms	
16" and 18" Floor Toms	
18" and 20" Bass Drums	
22", 24", 26" Bass Drums	

SHELL TYPE

Maple(4)/Birch(2) 6-ply (RF 7.5mm / RFP 5.4mm)
Maple(6) 6-ply (RF 7.5mm / RFP 5.4mm)
Maple(4)/Mahogany(2) 6-ply (RF 7.5mm / RFP 5.4 mm)
Maple(4)/Mahogany(2) 6-ply (RF 7.5mm / RFP 5.4 mm)
Maple(2)/Mahogany(4) 6-ply (RF 7.5mm / RFP 5.4mm)
Maple(4)/Mahogany(4) 8-ply (RF 10mm / RFP 7.2mm)
Maple(2)/Mahogany(6) 8-ply (RF 10mm / RFP 7.2mm)
Maple(2)/Mahogany(4) 6-ply (RF 7.5mm / RFP 5.4mm)
Maple(2)/Mahogany(6) 8-ply (RF 10mm / RFP 7.2mm)

BEARING EDGE

Rounded 45°
Rounded 45°
Rounded 45°
Fully Rounded
Fully Rounded
Fully Rounded
Fully Rounded
Fully Rounded
Fully Rounded

SONIC OUTPUT

Cutting projection for high-note pitch
Transitional mid-note; blend of warmth and cut
Top-end slap with added low/bottom end
Bracing low-end with controlled punch
Full, rounded sustain and gated attack
Fat, controlled low-end with smooth roll-off
Fat, controlled low-end with resonant warmth
Quick and Punchy with Powerful low-end
Booming bass tone with articulate punch

REFERENCE PURE

UNRESTRICTED TONAL RESPONSE

Reference
PURE

THE EVENPLY DIFFERENCE lies in thinner shell layers. Using the same hybrid wood composition as the Reference Recipe with thinner plies gives the Reference Pure shell a lean profile with increased strength. Combining the ultra thin EvenPly shell with more efficient shell hardware reduces overall drum weight by 30% for increased resonance, improved bottom end, and a more nuanced near field playing experience.



#834 Glacier Blue Sparkle
RFP923XSP/C



SNARE DRUMS

A thin EvenPly-6 shell with four outer Maple and two inner Birch plies for cut, projection, and smooth, balanced sound. 45° bearing edges provide superbly articulate sensitivity.

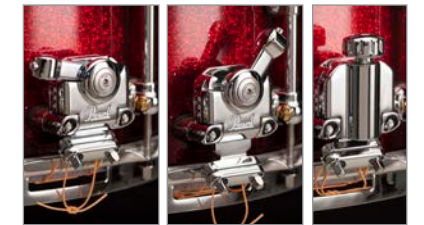

SR1000

SR1000 Glide-Lock Strainer's locking throw off lever and tension knob assures slip-free performance. (U.S. Patent #7220905, #7301087, #7365256)

HARDWARE



1.6MM FATTONE HOOPS' exclusive hemmed/welded edge (U.S. Pat. #8367917) gives increased strength to low mass design.



STL SWIVEL TUBE LUGS allow for increased resonance, minimal shell contact, and precisely aligned, no bind tuning.

SHELL	Low Mass EvenPly Maple, Birch & African Mahogany
SNARE	6 Ply Matching 13 x 6.5, 14 x 5, 14 x 6.5 (Sold Separately)
FINISH	Super High Gloss Lacquer / Lacquer Sparkles
HEADS	Remo Clear Emperor Tom, Powerstroke3 Bass
TOM MOUNTS	Aluminum OptiMount Suspension System
TOM ARMS	Sold Separately
HARDWARE	Chrome, Nickel, Black Chrome Plated, or Gold Plated
HOOPS	Low Mass FatTone Hoops
LUGS	Low Mass STL Swivel Tube Lugs

SHELLS

Boasting the same shell construction that made Reference drums a professional standard, Reference Pure's uninhibited, shell-focused tonality excels in any playing environment.

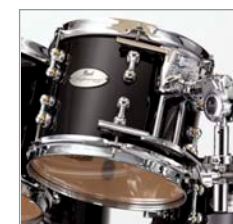

OPTIMOUNT

Aluminum Tom Mounts suspend the drum evenly across four tension points to allow resistance-free resonance in play.



AIR SUSPENSION RUBBER TIP

(U.S. Patent #5881981) isolates the tom from the floor, preventing tonal choke and increasing resonance.



GOLDEN RATIO AIR VENT

(U.S. Patent #7485791) is precision placed in the Fibonacci Spiral on toms to increase low-end response.

MUSIC CITY CUSTOM

HAND ASSEMBLED IN THE USA FOR TRUE PEARL ARTISTS... LIKE YOU



#415 Bronze Oyster



**TURN AROUND
GET IT WHEN YOU NEED IT.**

The concept is simple but revolutionary. Custom drums crafted from one of Pearl's four professional grade Shell Recipes in your choice of sizes and finishes; hand assembled in Nashville, Tennessee. Most orders are completed within 14 business days from the date we receive your order.



**CHOOSE THE RECIPE THAT
DEFINES YOUR SOUND.**

- | | |
|--|---|
| MASTERS MAPLE GUM
<i>(pg. 18-19)</i> Vital, explosive tonality with precise low-end decay. | REFERENCE PURE
<i>(pg. 21)</i> Lively, resonant timbre with increased body and sustain. |
| REFERENCE
<i>(pg. 20)</i> Maximum projection with powerful, formidable tone. | MASTERS MAPLE RESERVE
<i>(pg. 22)</i> Sonically-balanced attack with smooth midrange. |



MUSIC CITY CUSTOM

A FOUR DECADE TRADITION OF ARTIST CRAFTSMANSHIP



MCC: REFERENCE

Maximum projection with powerful, formidable tone.



#412 Black Oyster Glitter



MCC: REFERENCE PURE

Lively, resonant timbre with increased body and sustain.



#423 Vintage Gold Sparkle

GET THE GEAR YOU WANT WHEN YOU NEED IT.



IT ALL STARTS WITH THE SHELLS.

With four SST ply formulas and the most popular size options to choose from, each shell is individually inspected for roundness and edge integrity before entering the finishing phase.



CHOOSE FROM 35 TOUR READY FINISHES.

Pearl's Music City Custom Shop keeps 35 different durable finishes in stock. All USA made by Delmar and hand applied with a time tempered precision.



CNC DRILLED TO PERFECTION.

Pearl's unique CNC routing process means that all hardware is precision placed for accurate tuning and function.



HAND ASSEMBLED AND INSPECTED.

Each Music City Custom drum is hand assembled for a uniquely refined playing and ownership experience.



BUY IT ONCE, PLAY IT FOR LIFE.

Our goal is to complete each order within 14 business days from the date we receive it. Our final hand inspection certifies quality, our unbeatable Lifetime Warranty guarantees it.

For over 40 years, our exclusive USA Artist Custom shop has collaborated with some of drumming's biggest names to handcraft their personal touring kits. Pearl now invites you to experience the same level of unparalleled service with Music City Custom.



Barry Kerch (Shinedown) and Dustin Steinke (SIXX:A.M.) backstage with their MCC kits.



Casey Cooper (YouTube: COOP3RDRUMM3R) with his MCC RFP kit in #416 Black N' White Oyster.

MUSIC CITY CUSTOM

MASTERS MAPLE RESERVE



MCC: MASTERS MAPLE RESERVE

Pearl's classic MRV 4-ply shell with 4-ply re-rings, FatTone hoops, and CL bridge lugs for balanced Maple tone.



ARTIST DESIGNED, HAND ASSEMBLED

Explore the option of four premium SST drum shell types; precision drilled to order, assembled, and immediately available in your choice of 35 tour ready finishes. From classic sparkles and vintage pearls to timeless favorites, it's here and ready to define your command of the stage.

Music City Custom provides the true artist experience and a drum set like no other. Quick custom manufacturing, massive size and finish selection, industry leading craftsmanship, and Pearl's exclusive Lifetime Warranty all combine to set a new standard for USA born, high end drum sets.

35 IN-STOCK FINISHES

With a broad palette of visually radiant wrapped finishes, Music City Custom offers you 35 different Premium covering options from Delmar USA. From classic Sparkles and vintage Pearloids to Glass Glitters and Satins, it's all here and ready to inspire your drumming creativity.

The Vintage Vibe

Choose from quintessential Sparkles and Pearls for a classic statement that always looks fresh.

Current and Contemporary

Ultra bold and vibrant Glass Glitters and Mirror Chrome fit the bill for head-turning flash.

Abalone and Satin Moire

Mix things up with these variant, eye-catching textures and patterns.



MASTERS MAPLE RESERVE

A CLASSIC FORMULA FOR SONIC GREATNESS

Masters
MAPLE RESERVE



#355 Antique Walnut
MRV903XP/C

THE MASTERS LEGACY

Delivering arguably the greatest drum tones ever recorded, Pearl's fresh take on the legendary Maple/Gum shell recipe reaches new levels in dynamic sonic warmth and explosive low-end response.

Now, Pearl expands Masters Maple/Gum with updated finish and component options, making our first production Masterworks kit a true prize for the owner.



#111 Matte Natural

#343 Olive Burst

#353 Matte White



#355 Antique Walnut

#359 Twilight Burst

#839 Redburst Triband

Masters Maple Reserve is available in all 35 Music City Custom special order finishes - see Page 23.

Also available in 28 Special Order Lacquer finishes - see Back Cover.



#359 Twilight Burst
MRV924XEDP/C

CONFIGURATIONS

MRV903XP/C

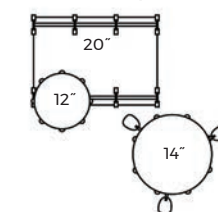

MRV923XSP/C

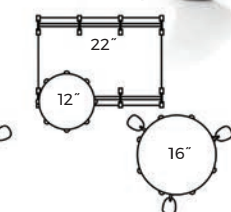

MRV924XEDP/C

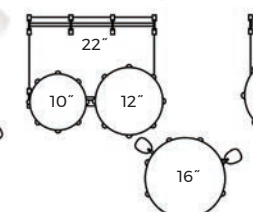

MRV943XP/C

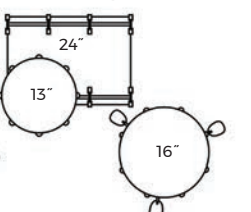

SHELL	4-ply (5mm) 100% Maple w/ 4-ply Maple Re-Rings
SNARE	Matching 14x5.5 or 14x6.5 (Sold Separately)
FINISH	Super High Gloss and Matte Lacquer
HEADS	Coated/Ported Powerstroke3 Bass (Front) Clear Powerstroke3 (Batter)
TOM MOUNTS	Aluminum OptiMount Suspension System
HARDWARE	Chrome***
HOOPS	Low Mass FatTone Hoops
LUGS	CL Bridge Lugs
BD MUFFLER	BDMF (Full Size)

SHELLS

4-ply Maple shell with 4-ply Maple Reinforcement Rings. A classic shell fusion delivering rich, sustained lows and controlled sonic punch.



HARDWARE



ALUMINUM OPTIMOUNT SUSPENSION SYSTEM

Light and efficient four-point contact design delivers secure tom mounting without penetrating the shell.



HARDWARE

FatTone Hoops - Rigid 1.6mm hemmed/welded edge extends sustain with punchy projection.

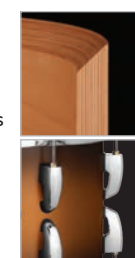

BEARING EDGE

Standard 45°

CL BRIDGE LUGS

A classic lug with a minimal contact arc for precise vibration control.

MASTERS MAPLE/GUM
THE EVOLUTION OF PREMIUM STUDIO TONE

Masters
MAPLE/GUM

THE MASTERWORKS STUDIO RECIPE, SIMPLIFIED.

Delivering arguably the greatest drum tones ever recorded, Pearl's fresh take on the legendary Maple/Gum shell recipe reaches new levels in dynamic sonic warmth and explosive low-end response.

Now, Pearl expands Masters Maple/Gum with updated finish and component options; making our first production Masterworks kit a true prize for the owner.



#186 Hand Rubbed Natural Maple
MMG924XSP/C

#187 White Silver Swirl with matching
14"x14" Floor Tom and matching
Havana Series Congas and Bongos
MMG924XP/C

FINISHES*



#186 Hand Rubbed Natural Maple



#187 Silver White Swirl
(Shell Packs: Stock, Components: Special Order)

CONFIGURATIONS

MMG904XP/C

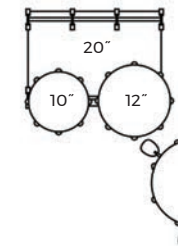

MMG924XP/C

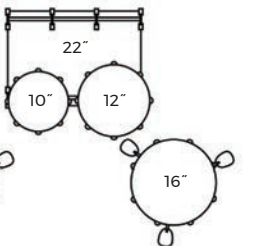

SHELL	EvenPly Six (6-ply, 5.4mm) North American Maple/Gum
FINISH	Hand-Rubbed Natural Wax or Premium USA Wrap
HEADS	Remo Coated Ambassador, Powerstroke3 Bass
TOM MOUNTS	OptiMount Aluminum Suspension System
HARDWARE	Chrome
HOOPS	MasterCast Die-Cast
LUGS	CL Bridge Lugs

SHELLS

EvenPly-6, 4-ply Maple outer with 2-ply Cumwood inside -The natural warmth of Maple is enhanced by Gumwood's dense, controlling character.



HARDWARE



MASTERCAST HOOPS

Escalates weight for tonal body and increases volume in high velocity play.



BEARING EDGE

Outer 60° - Gives increased power and bite to a thinner hybrid shell.



CL BRIDGE LUGS

A classic look with minimal shell contact for precise vibration control. CL100 / 250

MASTERS MAPLE COMPLETE

AN ALL MAPLE DRUM SHELL FIT FOR THE MASTERS LEGACY

Masters
MAPLE COMPLETE

FINISHES

Five premium finishes are available in four preconfigured shell packs, as well as a host of component and add-on drums.



#448 White Marine Pearl #823 Cain And Abel #836 Red Burst Stripe
#837 Chrome Contrail #841 Piano Black With Silver Stripe



#836 Red Burst Stripe
with added 10"x7" Tom and 16"x16" Floor Tom
MCT903XP/C

#823 Cain and Abel
A2 Custom graphic derived from "Cain&Abel: The Offering"
by Illustrator Jessica Hancock, used with permission

HARDWARE



BEARING EDGE

Standard 45° - Pearl's original precision edge adds sustain through reduced shell-to-head contact.



CL BRIDGE LUGS

A classic look with minimal shell contact at separate points for precise vibration control.



HARDWARE

2.3mm SuperHoop II Hoops - Made to maintain tuning integrity in heavy play while delivering maximum shell resonance.

SHELL	EvenPly Six (6-ply, 5.4mm) 100% Maple
SNARE	Matching 14x5.5 or 14x6.5 (Sold Separately)
FINISH	Super High Gloss Lacquer or Premium USA Wraps
HEADS	Remo UT Pinstripe Tom, Ported UT Powerstroke3 Bass
TOM MOUNTS	OptiMount Suspension System
HARDWARE	Chrome
HOOPS	SuperHoop II 2.3mm Triple Flanged
LUGS	CL Bridge Lugs

SHELLS

EvenPly-Six (5.4mm) North American Maple - Fuses reduced thickness, cross laminated ply panels for expanded tonal purity and increased resonance.



UNPARALLELED SOUND. ATTAINABLE PRICE.

Fully loaded with all the elements that made Pearl's Masters Series a must for the touring drummer, Masters Maple Complete offers a tonally superior percussive statement for the road ready pro.

CONFIGURATIONS

MCT903XP/C

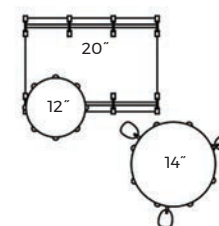

MCT923XSP/C

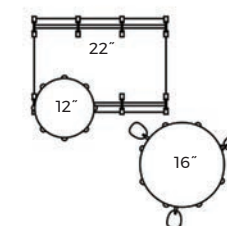

MCT924XEDP/C

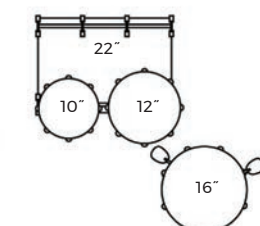

MCT943XP/C

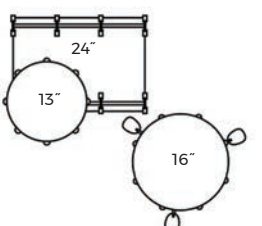

SESSION STUDIO SELECT

A COMPLETELY NEW TAKE ON THE FULL SPECTRUM SOUND

A TRUE PEARL ORIGINAL, WITH A FRESH, GROOVE INSPIRING VIBE.

Taking a tip from the Masterworks spectrum, Session Studio Select's unparalleled combination of Masters-grade Birch and African Mahogany deliver a refined standout for recording and gigging.



#112 Natural Birch
STS944XP/C

FINISHES

HIGH GLOSS LACQUER



#112 Natural Birch #314 Gloss Barnwood Brown #315 Antique Crimson Burst

PREMIUM DELMAR WRAP



#405 Nicotine White Marine Pearl #414 Ice Blue Oyster #766 Black Mirror Chrome

CONFIGURATIONS

STS905XP/C

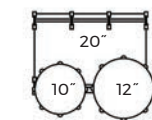

STS925XP/C

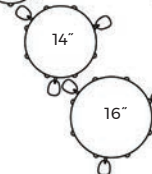
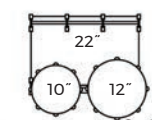

STS944XP/C

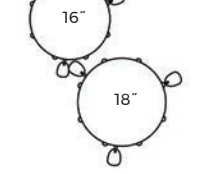
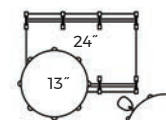

#314 Gloss Barnwood Brown
STS925XSP/C

SHELL	EvenPly Six (6-ply, 5.4mm) Birch/African Mahogany
SNARE	14x5.5, 14x6.5, or 14x8 Matching Wood* (Sold Separately)
FINISH	Premium Wrapped or High Gloss Lacquer
HEADS	Remo Pinstripe Clear Tom, Powerstroke3 Bass, UT Coated Snare
TOM MOUNTS	OptiMount Suspension System
TOM ARMS	Sold Separately
HARDWARE	Chrome
HOOPS	SuperHoop II 2.3mm Triple Flanged
LUGS	RL Lugs

SHELLS

EvenPly-Six Birch/African Mahogany. A unique sonic dichotomy of piercing projection, smooth low-end and pre-EQ'd punch.



SESSION STUDIO SELECT

PROFESSIONAL SOUND. CLASSIC VALUE.

The Session tradition of value for the drummer lives on with three specially priced shell packs, each including a FREE added floor tom.



BEARING EDGE

Outer 60-Degree. Increases volume and punch without harsh overtones.



HARDWARE

SuperHoop II, 2.3mm Triple-Flanged hoops for rigid tuning stability without robbing the shell of sustain.

CRYSTAL BEAT

THE ORIGINAL SEAMLESS ACRYLIC DRUM SET



#731 RUBY RED
CRB525FP/C

WITH ADDED 22"x16" BASS DRUM (CRB2216BX/C)
AND ADDED ROCKET TOMS IN #730 ULTRA CLEAR

CRYSTAL BEAT



Originating in 1973, Pearl's Crystal Beat Acrylic drums feature a 7mm molded/seamless Acrylic shell for a vivid combination of cutting tonal power and stunning visual appeal.

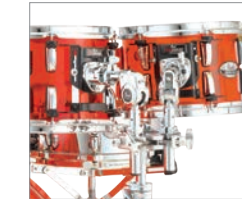

HARDWARE

Toms include the OptiMount suspension system for increased sustain and 1.6mm triple-flanged hoops for attack and punchy tonal body.



#732 Tangerine Glass
CRB543P/C



#730 Ultra Clear

Crystal Beat is available in a choice of four engaging colors, a host of sizes and set-ups, and even single-headed and Rocket tom options for a clearly striking drum statement.

SHELL	6mm (7mm on Bass Drums) Seamless Molded Acrylic
SNARE	Matching Free Floater (Sold Separately)
FINISH	Transparent
HEADS	Transparent 2-Ply on Tom Batters Single-Ply Resonant
TOM MOUNTS	OptiMount Suspension System
TOM ARMS	Sold Separately
HARDWARE	Chrome
HOOPS	Chrome 1.6mm Triple-Flanged
LUGS	CB Mid-Lugs on Toms, CB Fat-Lugs on Bass

SHELLS

Loud and immediate, delivers pummeling straight tone and yielding feel. Dual 45° bearing edge with a rounded apex, adding control and increased articulation to acrylic's sonic signature.



FINISHES



CRB524P/C

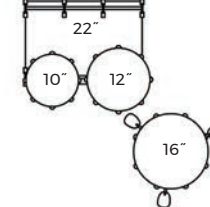

CONFIGURATIONS

CRB524FP/C

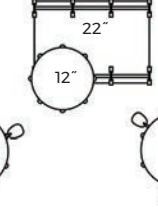

CRB525FP/C

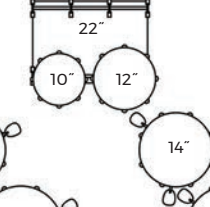

CRB503P/C

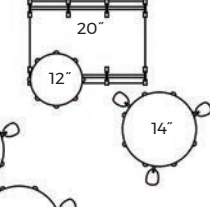

CRB543P/C

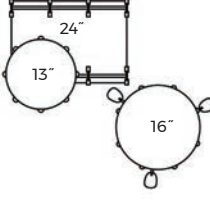

DECADE MAPLE

A DRUM KIT TO YEARS IN THE MAKING



FINISHES

- #216 Kobalt Blue Fade
- #225 Classic Satin Amburst
- #229 White Satin Pearl
- #260 Satin Brown Burst
- #261 Gloss Deep Red Burst
- #262 Satin Black Burst



#225 Classic Satin Amburst
DMP927SP/C



#229 White Satin Pearl
(Snare Sold Separately)
DMP943XP/C

CONFIGURATIONS

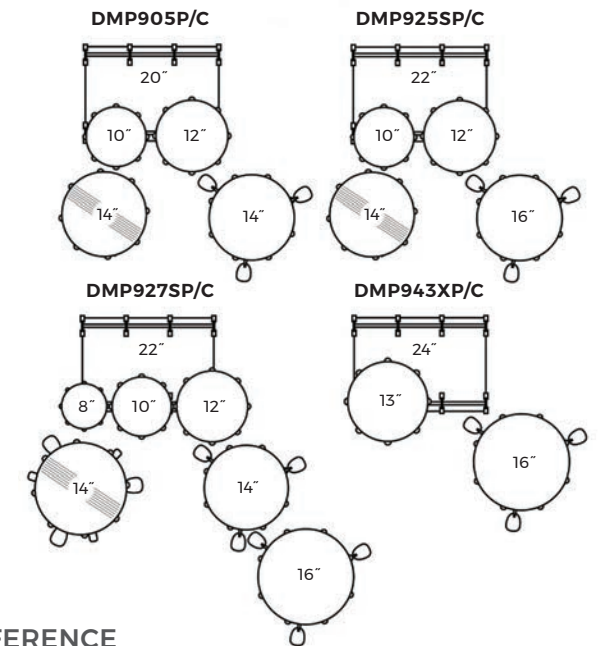

THE DECADE DIFFERENCE

SHELL	Even Ply 6 (5.4mm) 100% Maple
SNARE	Matching 14x5.5
FINISH	High-Gloss / Matte Lacquer
HEADS	Remo UT Clear Ambassador Tom, Ported UT Powerstroke3 Bass
TOM MOUNTS	Opti-Loc Mounting System
HARDWARE	Chrome
HOOPS	1.6mm Steel Triple Flanged
LUGS	NDL Lugs
BD MUFFLER	BDMM (Mini)

SHELLS

6-ply/5.4mm Maple - Thin (but powerfully strong)
Pearl's SST shell reacts quickly to the stroke with beautifully resonant highs and thundering lows.



DECADE MAPLE

Built to push the boundaries of performance and price, Decade Maple Series drums elevate the playing field for the advancing drummer with pro features and unbeatable value.



OPTI-LOC MOUNTING SYSTEM

This three-point isolation mount suspends the drum at two tuning points and one of the drum's air vents for solid, stable play.



HARDWARE

Uni-Lock gearless Tom Arms.
R40 Air Suspension Floor Tom feet.
NDL Mini Lugs: For reliable, rock solid durability and sound.

EXPORT LACQUER

THE LEGENDS OF TOMORROW, PLAY EXPORT TODAY

The Export Series 30 year pedigree of unbeatable quality and value shines on with Reference-inspired shell woods and high impact hardware, giving the rising player a truly high end playing platform.

EXPORT

THE BEST SELLING DRUM SET OF ALL TIME



#220 Satin Brown with added Modern Utility 14"x10" Floor/Snare (MUS1410FMC/C220), Short Fuse 10" x 4.5" snare (SFS10/C31), and 6" x 12" Rocket Tom (AL0612103) **EXL705N/C**



#49 Mirror Chrome with EXX22/C Add-On Pack: 22" Bass Drum and 8" Tom **EXX725S/C**

SHELLS

6-ply/7.5mm Poplar/Asian Mahogany. A Pearl SST (Superior Shell Technology) blend for high volume resonance and sustained low-end punch.



CONFIGURATIONS

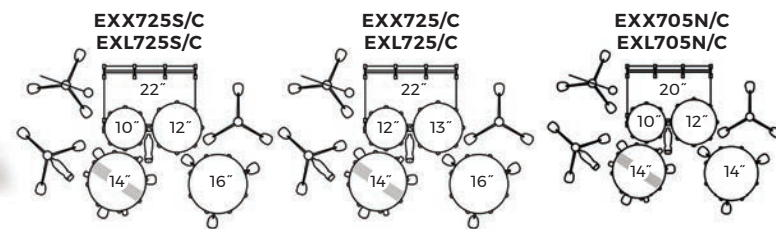

INCLUDES HWP830 HARDWARE PACK

Export Series drums are available in three preconfigured packages with our robust 830 Series hardware, and feature a choice of gorgeous lacquer (EXL) or durable wrapped (EXX) finishes.

FINISHES



830 SERIES HARDWARE

Sophisticated, sturdy, and efficient, Export's 830 Series Boom (BC830), Cymbal (C830), and Snare (S830) stands all feature gearless Uni-Lock Tilters for pinpoint positioning, and robust double-braced tripods for secure stability in play. The H830 Hi-Hat stand also features swivel legs that accommodate double pedals.



P930 PEDAL

Featuring the longboard styling and feel of Pearl's Demon Drive pedal, the P930 offers two chain drive cam options for power, speed, and control.



OPTI-LOC MOUNTING SYSTEM

Pearl's three way tom mount delivers wobble free stability by suspending the drum at two tuning points and one of the drum's two air vents.



SHELL	6 Ply 7.5mm Birch/Poplar & Asian Mahogany Blend
SNARE	14 x 5.5 Matching Wood Snare
FINISH	Choice of 4 High Gloss Lacquer Finishes and 1 Satin Finish
HEADS	Remo Clear Tom Head, Powerstroke Bass Head
TOM MOUNTS	Opti-Loc Mounting System
TOM ARMS	TH70I
DRUM HARDWARE	Chrome
HARDWARE	P930, BC830, C830, H830, S830
BD MUFFLER	BDMM (Mini)

SHELL	6-Ply 7.5mm Poplar/Asian Mahogany Blend
SNARE	14 x 5.5 Matching Wood Snare
FINISH	Choice of 7 Covered Finishes
HEADS	Remo Clear Tom Head, Powerstroke Bass Head
TOM MOUNTS	Opti-Loc Mounting System
TOM ARMS	TH70I
DRUM HARDWARE	Chrome
HARDWARE	P930, BC830, C830, H830, S830
BD MUFFLER	BDMM (Mini)

FINISHES



MIDTOWN

BIG GIG, SMALL RIG, HUGE SOUND



#701 Black Gold Sparkle
MDT764P/C

SHELLS



6 Ply (7.5 mm) Poplar. Quick and biting attack with lively overtones.

CONFIGURATIONS

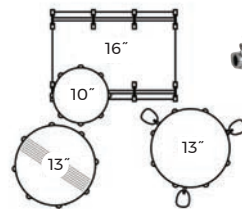

FINISHES



HARDWARE



Lift used on Midtown raises the drum to the optimal position for your pedal.

SETTING THE PULSE FOR THE METROPOLITAN GROOVE

Pearl's ultra portable Midtown Kit is the perfect sounding board for full size sound and play in a smaller footprint. Ideal for tight gigging spaces on a budget.

SHELL	6 Ply (7.5 mm) Poplar
SNARE	Matching 13x5.5 Wood Snare Drum
FINISH	Choice of 2 Covered Finishes
HEADS	Remo UC Clear Tom Remo UC Clear Powerstroke Batter Bass Remo UC Coated Snare
TOM ARMS	TH701
HARDWARE	Chrome

INSTANTLY PORTABLE

The Midtown Kit's compact size quickly breaks down into two optional gig bags (PMTBG) for quick transport.



ROCKET TOMS

For striking staccato tone that's both melodic and piercing, Pearl's Rocket Toms are 6" pitched toms in varying lengths made to expand the sonic palette of any drum kit.

Available in sets or as individual components in Aluminum. Finishes: #103 Piano Black, #109 Arctic White, or #730 Ultra Clear Acrylic.



AL0612	6" x 12"
AL0615	6" x 15"
AL0618	6" x 18"
AL0621	6" x 21"
ALX1215	6" x 12", 6" x 15" (w/ T890)
ALX1821	6" x 18", 6" x 21" (w/ T890)
CRB612/C	6" x 12" (Acrylic #730 Ultra Clear)
CRB615/C	6" x 15" (Acrylic #730 Ultra Clear)
CRB618/C	6" x 18" (Acrylic #730 Ultra Clear)
CRB621/C	6" x 21" (Acrylic #730 Ultra Clear)

COMPACT TRAVELER

BASS DRUM	18" w/ Base Frame & L-Arm Handle
SNARE	10" w/ Adjustable Snare Rake
STANDS	Sold Separately
CARRYING CASE	PSCPCTK (Sold Separately)
ADD ON PACK	PCTKT1014 Includes 10" & 14" Toms w/ Mounting Hardware

Take the rhythm on the road with Pearl's totally portable, super playable, ultra affordable beat maker. Perfect for School, Street, Practice, and Stage.



*HW/Cymbals sold separately



Pedal sold separately

PCTK1810



Add on pack (10" & 14" toms w/ mounting hardware)

PCTKT1014

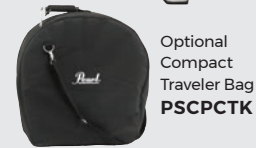

Optional Compact Traveler Bag
PSCPCTK



Optional Compact Traveler Add on Bag
PSCPCTKADD



#707 Bronze Metallic
RS525SC/C

ROADSHOW

IT'S YOUR TIME TO PLAY, START THE RIGHT WAY!

THE RHYTHM IS IN YOU

Drumming knows no age limit. Regardless of when your rhythmic journey starts, Pearl's Roadshow Series has a drum set package scaled for players of all ages that includes everything you need to get on the road to drumming greatness.



SHELL	9 Ply 7mm Asian White Poplar
SNARE	Matching Wood Snare
FINISH	Choice of 5 Covered Finishes
HEADS	Clear Tom Heads, Coated Snare Head, Self-Muffled Bass Head
TOM ARMS	Individually Locking 7/8" Tube Joint Holders
HARDWARE	Dual-Chain Drive Bass Drum Pedal Double-Braced Cymbal*, Snare and Hi-Hat Stands, Double-Braced Throne
CYMBALS	16" Brass Cymbal, 14" Brass/Hybrid Hi-Hat Cymbals
ACCESSORIES	Pro Drum Stick Bag, Two pairs of Maple 5A Sticks

CONFIGURATIONS

Complete Sets with Hardware, Cymbals, and Throne. Includes CH50/H50/S50*/P50/D50/16" Crash/14" Hi-Hats, Stick Bag, Sticks

RS584C/C

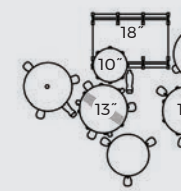

RS505C/C

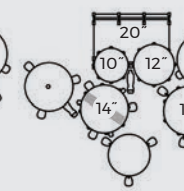

RS525SC/C

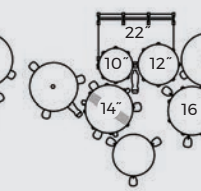

RS525WFC/C

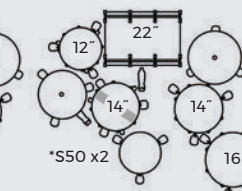

#706 Charcoal Metallic
RS584C/C

THE HEART OF THE ROADSHOW SOUND. Roadshow is crafted to be everything you'd expect from a Pearl Drum set, featuring a 9 ply Poplar shell for optimum tonal power.



#31 Jet Black

#91 Red Wine

#703 Aqua Blue Glitter



For additional info, testimonials, free assembly and instructional videos, and access to the largest drummer's community on the web, go to:



WWW.MYFIRSTDRUMSET.COM

ROADSHOW JR.

Pearl's Roadshow Jr. is NOT a toy. It's a serious, all-in-one, five piece drum set sized for kids under 8-years-old featuring hardware, cymbals, and sturdy White Poplar shell construction for an exceptionally powerful drumming start.

Complete with Hardware, Cymbals, and Throne for Drummers under 8.

RSJ465/C

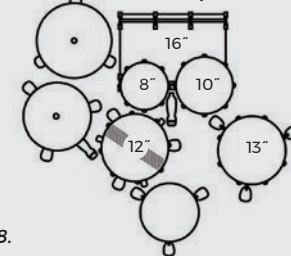

#31 Jet Black
RSJ465/C

#708 Grindstone Sparkle
RSJ465/C

e/MERGE
POWERED BY KORG



e/TRADITIONAL CONFIGURATION

10", 12" and 14" toms, a 14" snare, and PUREtouch Kick Pad, PUREtouch Cymbals, ICON e-Rack, MDL1 Module.
EM53T

The foundation of the e/MERGE electronic drum set is a custom designed, chrome plated ICON e-Rack system.



e/HYBRID CONFIGURATION

10", 12" and 14" toms, a 14" snare, and 18" acoustic bass drum, PUREtouch Cymbals, ICON e-Rack, MDL1 Module.
EM53HB

e/MERGE

NOT JUST A NEW STANDARD.

A NEW SOUND. A NEW FEEL. AND, A COMPLETELY NEW E-DRUMMING EXPERIENCE.

e/MERGE is about change, and change in the e-drum market has been way overdue. When we looked closely at every aspect of the current e-drumming experience with KORG, together we knew we could make a dramatic difference. And that difference begins with the all new e/MERGE module. Simple yet elegant in design, the e/MERGE MDL1 module features a full library of high definition, natural, organic and minimally processed acoustic Pearl drums. We then added the very best electronic, world, orchestral and specialty percussion sounds from KORG's vast library of pristine quality samples. But, the module is only part of the change.

There are three key elements that separate e/MERGE from anything that has come before. The all new MDL1 e/MERGE Module, KORG's amazing WAVE TRIGGER TECHNOLOGY and Pearl's acoustic-like PUREtouch electronic pads and cymbals combine to create an exceptional e-drumming experience.

e/MERGE MDL1 MODULE Simple, straight forward yet extremely powerful, the MDL1 module offers, a pair of powerful multicore processors, a full library of acoustic Pearl drums recorded in one of the world's most renowned studios, pristine samples from KORG's library and the variety of routing options every e-drummer needs.



WAVE TRIGGER TECHNOLOGY This ultra-fast and highly sensitive technology partially based upon KORG's groundbreaking Wave Drum allows even your stick choice to make a discernible difference in the sound of your drum.



PUREtouch PADS & CYMBALS

Perfectly sized pads designed to replicate the ultimate acoustic-like response. PUREtouch features layer upon layer of specially designed materials each selected for a specific quality that together create an e-experience never before possible.

(PUREtouch Pads U.S. Patent #10475424)
(PUREtouch Hi-Hats U.S. Patents #10475430, 10482855)



MODULE SPECIFICATIONS

SOUND GENERATOR	2 CPU (4 core + 2 core)
POLYPHONY	128 Voices
VOICE	700 HD Sound Library
DRUM KIT	35 HD Kits
EFFECTS	36
SONG RECORDING TYPE	44.1kHz, 16 Bit WAV
SONG RECORDING TIME	Approximately 12 Hours
CLICK TEMPO	BPM 30 - 300
BEAT	1/2 - 24/2, 1/4 - 24/4, 1/8 - 24/8, 1 - 24/8T, 1/16 - 24/16 (T=Triplet)
CLICK VOICES	10
CONTROLLERS	Knobs and Ambient Slider Control

DISPLAY CONNECTORS

3.25" x 1" Graphic LCD	
Master Out L/Mono & R	
Direct Out (8)	
Headphones Out	
Aux In TRS Mini	
Main Trigger inputs (DB-25 Connector)	
Accessory Inputs (3)	
USB to PC Port (Transport USB Audio & MIDI Data)	
USB-A (for WAV files and Settings Data)	
MIDI Output	
MIDI	
POWER SUPPLY	100-120V, 50-60Hz, Switching Power Supply
DIMENSIONS, WEIGHT	2.2lbs, 9"W x 7.5"D x 2"H

MIMIC PRO

POWERED BY SLATE

Download MIMIC PRO Software Updates and User Manual at pearl-electronics-support.com



MIMP24B

THE MOST AMAZING DRUM MODULE THE WORLD HAS EVER KNOWN.
SERIOUSLY, IT'S THAT GOOD.



Superior sound, accurate triggering and connectivity are the most important features of a drum module. Pearl Drums and Steven Slate have joined forces to create "Mimic Pro" - the world's most advanced percussion sound source for studio and live performance applications.

At the heart of this ground breaking unit is the new Steven Slate 5 drum library that features multi-channel drum samples recorded in world class studios. Each instrument supports adjustment of Attack, Sustain, Release, Tune, Pan and volume. Instead of substituting digital effects to create ambience, these instruments use the actual ambient recordings with separate adjustment of close, overhead and room mics.

Mimic Pro is the first drum module to implement a 7" IPS touch screen and the first to offer 2 mixers for independent headphone and front house outputs. Now that the drummer is responsible for triggering loops and other sounds for a performance, Mimic Pro can import audio files to trigger from your pads.

Storage is no longer a problem with Mimic's 120GB Solid State Drive and lightning fast loading time. Speaking of connectivity, Mimic Pro is compatible with Pearl TruTrac pads and a host of pads from other manufacturers. Top that off with sixteen audio outs, 16 Trigger inputs, independent SD card Slot, USB and Midi In & Out, Stereo Aux input and you would be hard pressed to find a better option for today's musician.

mimic PRO
POWERED BY SLATE



STATE OF THE ART FEATURES:

- 7" IPS Touch Screen with Programmable Data Wheel
- 120 gig Solid State drive
- 16 Dual Zone Inputs
- 16 Programmable Audio Outputs
- Midi In and Out
- High Quality Digital to Analog Converters
- Two completely separate mixers for headphone and Main outs. (Drummer gets a personal mix with and without effects independent of Main outputs)
- Import Wave, Aiff or MP3 sound files
- Compatible with most pads on the market
- Steven Slate Drums 5 Library
- 24 bit multi channel sample library with separate adjustment of Close, Overhead and Room mics.
- Onboard effects include EQ, Compression, Reverb with Room Sizes
- Individual Cymbal Volume Adjustments for Bell, Bow, Edge, Chik and Splash
- All AUX and Cymbal inputs have choke function.
- Supports triple and dual zone cymbals and dual zone hi hat.
- SD card slot and USB.
- Additional Instruments and Libraries will be available
- Stereo Aux In and Onboard Metronome
- Internal Recording for Loops and/or Performances

malletSTATION™

malletSTATION

THE WORLD'S FIRST 3.0 OCTAVE ADJUSTABLE RANGE ELECTRONIC MALLET CONTROLLER

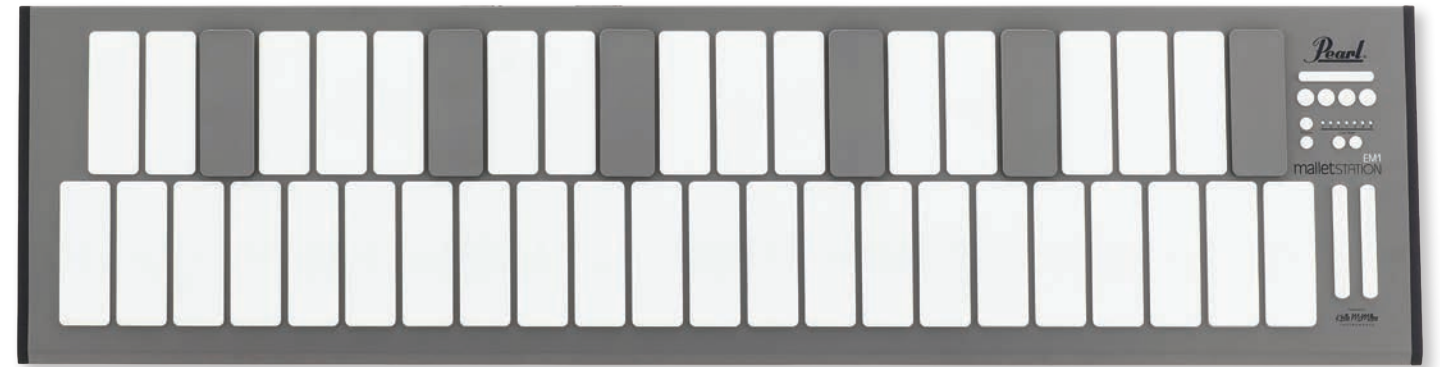

PRACTICE, PERFORM, COMPOSE ANYWHERE.

- USB Powered MIDI Mallet Keyboard Controller
- Universal Compatibility through phone/tablet/laptop
- Tech-Forward Design featuring KMI Smart Fabric Sensors
- Low Note, Adjustable, User defined 3.0 Octave Range
- Customizable mallet dampening and aftertouch modes for realistic performance techniques
- Natural feeling soft silicone keys, all-weather playing surface
- Assignable buttons and faders for customized control and functions
- Three assignable pedal inputs for expression and sustain
- Hybrid Aluminum and Steel Chassis design for durability and stability
- Optional MIDI Expander to use external MIDI Hardware (sold separately)
- Flexible mounting on desktop, X-stand, or module mounts (sold separately)
- Mounting plates, stands, cases, covers, and other peripherals (available separately)

EMI



Shown Mounted on Vibraphone with Field Frame



Sleek, modern design with an ultra thin 1.6" profile

- 43, 1.75" x 5" soft silicone keys - 3 faders and 4 buttons, MIDI assignable - 3 MIDI assignable 1/4" pedal inputs
- Bottom Note Range Shift up/down buttons - Octave up/down buttons - 1.6" H x 12.6" W x 49" L - 22.5 lbs

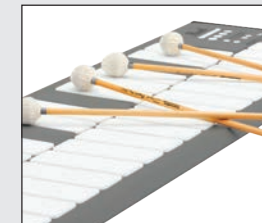

1.75" x 5" Soft Silicone Keys powered by KMI Smart Fabric Sensor Technology

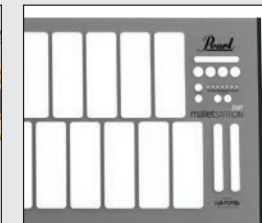

Software Assignable Control Panel with 3 Faders, 4 Buttons, plus Low Note and Octave Shift

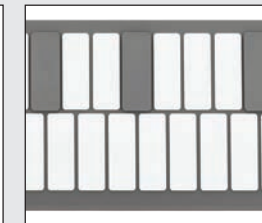

Moveable Accidental "Gap Caps" for visual cues when low note range is adjusted



Jack panel with USB MIDI, MIDI expander port, and 3 MIDI assignable 1/4" pedal inputs



Optional Dual Module Mounts allow malletSTATION to easily mount on racks, stands, and field frames

Pearl once again redefines the electronic percussion experience by introducing the revolutionary EMI malletSTATION adjustable range electronic mallet controller.

The EMI malletSTATION is a 3.0 octave adjustable range electronic mallet controller designed for all levels of player, from the beginning student through the gigging professional. The adjustable range function allows you to set the fundamental diatonic note of the instrument to what you need—low D xylophone? No problem! Powered exclusively by USB Bus Power, the malletSTATION is designed to be used with Mac, PC, iPad, iPhone, and Android devices, making it the first truly portable mallet percussion controller on the market.

Designed in collaboration with Keith McMillen Instruments, malletSTATION's tech-forward design features KMI's Smart Fabric

Sensor technology allowing the silicone bar material to have an extremely sensitive, natural response, including mallet dampening and aftertouch control, and all can be easily tailored to your individual playing style. The EMI features a master control section, with 3 programmable faders, 4 programmable buttons, and the fixed function low note and octave shift buttons. In addition, three assignable pedal inputs allow for flexibility in performance such as sustain, expression, or any MIDI parameter of your choice. These controls are fully programmable through a software editor so changing your configuration is as easy as clicking a mouse.

This is the controller that will grow with you throughout your playing career—from music apps on your phone or tablet, to professional digital audio workstations and sound libraries—your sounds and even the instruments you play are only limited by the software you run.

MUSIC CITY CUSTOM

SOLID SHELL SNARE DRUMS
HANDCRAFTED IN THE USA



SHELL	8mm w/ 6mm Solid Maple Re-Rings
EDGE	Standard 45°
HOOPS	SuperHoop II Triple-Flanged
LUGS	STL100
TENSION RODS	Stainless Steel
STRAINER	SR017
SNARES	SN1420I

Our handcrafted Solid Shell Snare Drums all feature Solid Maple Reinforcement Rings bonded to both top and bottom of the shell interior.

DISCOVER THE ALL NEW, MADE IN USA SNARE DRUM YOU'VE BEEN WAITING FOR.

A singular tonal expression that elevates your approach to playing - and feeling - the drums.

Pearl's Music City Custom Solid Shell Snare Drums are uniquely refined, American made percussion instruments crafted with time honored precision. Using an old world technique derived from the shipbuilding trade, each solid shell is meticulously hand-formed from a steam treated plank of premium North American lumber.

Each Music City Custom Solid Shell Snare is then drilled with CNC precision before being hand finished and assembled by our Custom Shop team in Nashville, TN.

The natural beauty of each shell is further refined with a hand-rubbed oil finish available in a choice of standard Nashville Natural or with one of our exceptional, exotic inlay options. Pearl's Music City Custom Solid Shell Snare Drums are truly instruments elevated above all others.



SOLID SHELL WOOD OPTIONS



SOLID MAPLE

The standard for premium, tonally centered midrange punch and restrained overtone.



SOLID CHERRY

Slightly brighter in tone than Maple with cutting projection. Best suited for a higher velocity stroke.



SOLID WALNUT

A fat growl with a naturally darker tone, the sound of Walnut is a perfect complement to its luxurious grain.



SOLID ASH

Brighter, louder, and with the crack of a homerun hit, the tonal quality of Ash is punchy with extended sustain.

FINISH AND INLAY OPTIONS

Craft an instrument that truly demands your attention. Each Solid Shell Wood Option is available in your choice of hand rubbed Nashville Natural (without inlay) or configured with one of these exotic inlay options:

#1002
KINGWOOD ROYAL INLAY
(Shown on 14" x 6.5" Maple)
Centered Nicotine White Marine Pearl band surrounded by dual Kingwood inlay strips.
· Available only on 6.5" models



#1003
DUOBAND EBONY MARINE INLAY
(Shown on 14" x 6.5" Ash)
A White Nicotine Marine Pearl band surrounded by dual inlay strips of Macassar Ebony.
· Available only on 6.5" models



#1004
BOXWOOD-ROSE TRIBAND INLAY
(Shown on 14" x 6.5" Cherry)
Three thin bands of Artisan Rosewood and Boxwood creates a stunning inlay.
· Available only on 6.5" models



#1001
KINGWOOD CENTER INLAY
(Shown on 14" x 5" Maple)
A dark, dense inlay from the exotic Brazilian Rosewood family with a rich vertical grain.
· Available on all 5" & 6.5" models



#1005
NICOTINE WHITE MARINE INLAY
(Shown on 14" x 5" Maple)
Embeds a single 6mm band of White Nicotine Marine Pearl in the shell center.
· Available only on 5" models



#1006
BOXWOOD-ROSE SINGLE INLAY
(Shown on 14" x 5" Walnut)
A single strip of combined Artisan Rosewood and Boxwood for an elegant inlay.
· Available only on 5" models



#1007
EBONY SINGLE INLAY
(Shown on 14" x 5" Maple)
A solitary center inlay of imported Macassar Ebony.
· Available only on 5" models



PRESIDENT SERIES SNARES

PHENOLIC & DELUXE



President Series Phenolic

PSP1455S75/C	14" x 5.5"
SHELL	Hermetically Pressurized 4mm Phenolic
FINISH	#452 Pearl White Oyster
HOOPS	SuperHoop II (SH1410B/1410S)
LUGS	BSL55
TENSION RODS	T061L
MUFFLER	IM100PHC
STRAINER	SR17A / SR150E
SNARES	SN1420I
FIBER CASE	Included



President Series Deluxe

PSD1455SE/C	14" x 5.5"
SHELL	6-ply 7.5mm Lauan
FINISH	#767 Desert Ripple #768 Ocean Ripple
HOOPS	SuperHoop II (SH1408B/1408S)
LUGS	BSL55
TENSION RODS	T061L
MUFFLER	IM100W
STRAINER	SR17A / SR150E
SNARES	SN1420I



#767 Desert Ripple
PSD1455SE/C



#768 Ocean Ripple
PSD1455SE/C

SIGNED 75TH ANNIVERSARY EDITION. LIMITED QUANTITIES WORLDWIDE.

REFERENCE SNARES

THE ULTIMATE STABLE OF SNARES



All Reference snare drums feature Pearl's SR1000 Glide-Lock Strainer, which includes a locking throw off lever and tension knob that won't loosen no matter how hard you play. Low-friction technology permits smooth gliding action for ultra quiet, super precise motion. U.S. Patent #7220905, #7301087, #7365256



RF1365S/C	13" x 6.5"
SHELL	20 ply (25mm): Maple 14 + Birch 6
HOOPS	MasterCast (DC1308/1308S)
LUGS	BRL65
TENSION RODS	SST5047 Stainless Steel
STRAINER	SR1000 Glide-Lock Strainer
SNARES	SN1320D Ultra Sound "D" type



RF1365S/C



RFP1365S/C

RFP1365S/C	13" x 6.5"
SHELL	6 ply (5.4 mm): Maple 4 + Birch 2
HOOPS	FatTone Hoops (FH1308/1308S)
LUGS	STL65
TENSION RODS	SST5047 Stainless Steel
STRAINER	SR1000 Glide-Lock Strainer
SNARES	SN1320D Ultra-Sound "D" type

RF1450S/C	14" x 5"
SHELL	20 ply (25mm): Maple 14 + Birch 6
HOOPS	MasterCast (DC1410/1410S)
LUGS	BRL55
TENSION RODS	SST5047 Stainless Steel
STRAINER	SR1000 Glide-Lock Strainer
SNARES	SN1420D Ultra Sound "D" type

RFP1450S/C	14" x 5"
SHELL	6 ply (5.4 mm): Maple 4 + Birch 2
HOOPS	FatTone Hoops (FH1410/1410S)
LUGS	STL55
TENSION RODS	SST5047 Stainless Steel
STRAINER	SR1000 Glide-Lock Strainer
SNARES	SN1420D Ultra-Sound "D" type

RF1465S/B	14" x 6.5"
SHELL	20 ply (25mm): Maple 14 + Birch 6
HOOPS	MasterCast (DC1410/1410S)
LUGS	BRL65
TENSION RODS	SST5047 Stainless Steel
STRAINER	SR1000 Glide-Lock Strainer
SNARES	SN1420D Ultra Sound "D" type

RFP1465S/C	14" x 6.5"
SHELL	6 ply (5.4 mm): Maple 4 + Birch 2
HOOPS	FatTone Hoops (FH1410/1410S)
LUGS	STL65
TENSION RODS	SST5047 Stainless Steel
STRAINER	SR1000 Glide-Lock Strainer
SNARES	SN1420D Ultra-Sound "D" type

RFB1450	14" x 5"
SHELL	3mm Brass
HOOPS	MasterCast (DC1410/1410S)
LUGS	LBRL55
TENSION RODS	SST5047 Stainless Steel
STRAINER	SR1000 Glide-Lock Strainer
SNARES	SN1420D Ultra-Sound "D" type

RFB1465	14" x 6.5"
SHELL	3mm Brass
HOOPS	MasterCast (DC1410/1410S)
LUGS	BRL65
TENSION RODS	SST5042 Stainless Steel
STRAINER	SR1000 Glide-Lock Strainer
SNARES	SN1420D Ultra-Sound "D" type

RFS1450	14" x 5"
SHELL	2.5mm Cast Steel / 2.5mm R-Ring
HOOPS	MasterCast (DC1410/1410S)
LUGS	BRL55
TENSION RODS	SST5047 Stainless Steel
STRAINER	SR1000 Glide-Lock Strainer
SNARES	SN1420D Ultra-Sound "D" type

RFS1465	14" x 6.5"
SHELL	2.5mm Cast Steel / 2.5mm R-Ring
HOOPS	MasterCast (DC1410/1410S)
LUGS	BRL65
TENSION RODS	SST5047 Stainless Steel
STRAINER	SR1000 Glide-Lock Strainer
SNARES	SN1420D Ultra-Sound "D" type



RF1450S/C



RFP1450S/C



RFB1450



RFB1465



RF1465S/B



RFP1465S/C



RFS1450



RFS1465

SERIES COMPONENT

MASTERS, SESSION, DECADE
CLASSIC PEARL SOUND

DRUM SET SERIES SNARE DRUMS

Made to match the sound and feel of your Pearl drum set.



TASK-SPECIFIC INNOVATION

Pearl's unique Free Floating Snare chassis removes all hardware from the shell to greatly improve resonance and projection.

By combining the tonal character of each shell type with its ideally matched depth, each Free Floating snare drum is engineered to fit a specific task by model and gives you a unique voice for any sonic situation.

FREE FLOATING

THE ULTIMATE PURITY OF SOUND



CLICK-LOCK THROW-OFF SYSTEM Engineered with Polymer bearings for precise and smooth action. Unique nylon grip mechanism locks the snares into place.



MRV1455S/C



MRV1465S/C

MRV1455S/C 14" x 5.5"

SHELL	4 Ply Maple with 4 ply Maple R-Rings
HOOPS	FatTone (FH1410/1410S)
LUGS	STL55
TENSION RODS	SST5055 Stainless Steel
STRAINER	SR017
SNARES	SO22N

MRV1465S/C 14" x 6.5"

SHELL	4 Ply Maple with 4 ply Maple R-Rings
HOOPS	FatTone (FH1410/1410S)
LUGS	STL65
TENSION RODS	SST5047 Stainless Steel
STRAINER	SR017
SNARES	SO22N



Deep, rich snare power with short, even sustain decay.
FTAL1480



Ultimate in throaty, deep snare growl. Shortened decay.
FTMH1480

FTAL1480 14" x 8"

SHELL	1.2mm Seamless Aluminum
HOOPS	MasterCast (DC1410/DC1410S)
LUGS	FT80
TENSION RODS	SST5042
STRAINER	SR160F
SNARES	SN1442C

FTMH1480 14" x 8"

SHELL	8 ply (10mm) African Mahogany
HOOPS	MasterCast (DC1410/DC1410S)
LUGS	FT80
TENSION RODS	SST5042
STRAINER	SR160F
SNARES	SN1442C



MCT1455S/C



MCT1465S/C

MCT1455S/C 14" x 5.5"

SHELL	6 Ply Maple (5.4mm)
HOOPS	SuperHoop II (SH1410B/1410S)
LUGS	CL55
TENSION RODS	T062
STRAINER	SR017
SNARES	SO22N

MCT1465S/C 14" x 6.5"

SHELL	6 Ply Maple (5.4mm)
HOOPS	SuperHoop II (SH1410B/1410S)
LUGS	CL65
TENSION RODS	T061L
STRAINER	SR017
SNARES	SO22N



Lower overtone body, preserves crisp top-end snare snap.
FTPB1465



Full, rounded bottom frequencies. Extra midrange body.
FTMMH1465

FTPB1465 14" x 6.5"

SHELL	1.2mm Phosphor Bronze
HOOPS	MasterCast (DC1410/DC1410S)
LUGS	FT65
TENSION RODS	SST5042
STRAINER	SR160F
SNARES	SN1420C

FTMMH1465 14" x 6.5"

SHELL	6 ply (7.5mm) 4 ply Maple w/ 2 ply inner African Mahogany
HOOPS	MasterCast (DC1410/DC1410S)
LUGS	FT65
TENSION RODS	SST5042
STRAINER	SR160F
SNARES	SN1420C



STS1480S/C



STS1465S/C

STS1480S/C 14" x 8"

SHELL	6-ply (5.4mm) Birch/African Mahogany
HOOPS	SuperHoop II (SH1410B/1410S)
LUGS	CL100
TENSION RODS	T061L
STRAINER	SR017
SNARES	SO22N

STS1465S/C 14" x 6.5"

SHELL	6-ply (5.4mm) Birch/African Mahogany
HOOPS	SuperHoop II (SH1410B/1410S)
LUGS	CL65
TENSION RODS	T061L
STRAINER	SR017
SNARES	SO22N



Full-spectrum, both bright in punch and warm in tone.
FTBR1450



Punchy and smooth. A perfect "go-to" snare.
FTMM1450

FTBR1450 14" x 5"

SHELL	1mm Brass
HOOPS	MasterCast (DC1410/DC1410S)
LUGS	FT50
TENSION RODS	SST5042
STRAINER	SR160F
SNARES	SN1420I

FTMM1450 14" x 5"

SHELL	6 ply (7.5mm) Maple
HOOPS	MasterCast (DC1410/DC1410S)
LUGS	FT50
TENSION RODS	SST5042
STRAINER	SR160F
SNARES	SN1420I



STS1455S/C



DMP1455S/C

STS1455S/C 14" x 5.5"

SHELL	6-ply (5.4mm) Birch/African Mahogany
HOOPS	SuperHoop II (SH1410B/1410S)
LUGS	CL55
TENSION RODS	T062
STRAINER	SR017
SNARES	SO22N

DMP1455S 14" x 5.5"

SHELL	6 Ply Maple (5.4mm)
HOOPS	1.6mm Steel (RH1408/1408S)
LUGS	NDL55/C
TENSION RODS	TR5052
STRAINER	SR700
SNARES	SNW1420



1mm shell for bright, open attack with ringy overtone.
FTSS1435



Dense all Birch shell delivers bright, open attack.
FTBB1435

FTSS1435 14" x 3.5"

SHELL	1mm Stainless Steel
HOOPS	MasterCast (DC1410/DC1410S)
LUGS	FT35
TENSION RODS	SST5035
STRAINER	SR160F
SNARES	SN1420D

FTBB1435 14" x 3.5"

SHELL	6 ply (5.4mm) Birch
HOOPS	MasterCast (DC1410/DC1410S)
LUGS	FT35
TENSION RODS	SST5035
STRAINER	SR160F
SNARES	SN1420D

SENSITONE HERITAGE ALLOY

LEGENDARY, VITAL SNARE TONE FROM STUDIO TO STAGE

The Sensitone sound has always been drawn from an amalgamation of The Heritage Alloys (Aluminum, Black-over-Brass, and Steel) for the necessary, immediate tones of yesterday's chart toppers with an undeniably modern sensibility. Sensitone Heritage Alloy snare models employ these three original metal shell types to deliver essential tone and power with the right gig-ready touches.

Engineered for performance perfection, Sensi Tone Premium snare drums feature a choice of 14" models, available in 5" and 6.5" depths, in Patina Beaded Brass, Beaded Phosphor Bronze, or even North American Maple shells. Additionally, the African Mahogany 15" x 5" Baritone snare brings a deep, fresh voice to the tonal pallet.

SENSITONE PREMIUM

IMMACULATE PERCUSSION



Dry, focused crack with quick decay.
STH1450AL



Full, guttural snare bellow with little overtone.
STH1465AL

STH1450AL	14" x 5"
SHELL	1.2mm Seamless Aluminum
HOOPS	SuperHoop II (SH1410B/1410S)
LUGS	CL55
TENSION RODS	T061L
STRAINER	SR017
SNARES	SN1420I

STH1465AL	14" x 6.5"
SHELL	1.2mm Seamless Aluminum
HOOPS	SuperHoop II (SH1410B/1410S)
LUGS	CL65
TENSION RODS	T061L
STRAINER	SR017
SNARES	SN1420I



Bright and responsive with lively overtone.
STA1450FB



Bold projection with controlled ring sustain.
STA1465FB

STA1450FB	14" x 5"
SHELL	1.5mm Beaded Brass
HOOPS	SuperHoop II (SH1410B/1410S)
LUGS	ARL55
TENSION RODS	SST5047
STRAINER	SR150
SNARES	SN1420I

STA1465FB	14" x 6.5"
SHELL	1.5mm Beaded Brass
HOOPS	SuperHoop II (SH1410B/1410S)
LUGS	ARL65
TENSION RODS	SST5047
STRAINER	SR150
SNARES	SN1420I



Perfect blend of attack and brassy body.
STH1450BR



An elegant solution for punch and warmth.
STH1465BR

STH1450BR	14" x 5"
SHELL	1mm Beaded Brass
HOOPS	SuperHoop II (SH1410B/1410S)
LUGS	CL55
TENSION RODS	T061L
STRAINER	SR017
SNARES	SN1420I

STH1465BR	14" x 6.5"
SHELL	1mm Beaded Brass
HOOPS	SuperHoop II (SH1410B/1410S)
LUGS	CL65
TENSION RODS	T061L
STRAINER	SR017
SNARES	SN1420I



Musical and penetrating with mid-range power.
STA1450PB



Bellowing low-end wallop with smooth articulation.
STA1465PB

STA1450PB	14" x 5"
SHELL	1.2mm Phosphor Bronze
HOOPS	SuperHoop II (SH1410B/1410S)
LUGS	ARL55
TENSION RODS	SST5047
STRAINER	SR150
SNARES	SN1420I

STA1465PB	14" x 6.5"
SHELL	1.2mm Phosphor Bronze
HOOPS	SuperHoop II (SH1410B/1410S)
LUGS	ARL65
TENSION RODS	SST5047
STRAINER	SR150
SNARES	SN1420I



Crisp, sensitive high-pitched snap.
STH1450S



Belting crack with mild midrange overtone.
STH1465S

STH1450S	14" x 5"
SHELL	1mm Beaded Steel
HOOPS	SuperHoop II (SH1410B/1410S)
LUGS	CL55
TENSION RODS	T061L
STRAINER	SR017
SNARES	SN1420I

STH1465S	14" x 6.5"
SHELL	1mm Beaded Steel
HOOPS	SuperHoop II (SH1410B/1410S)
LUGS	CL65
TENSION RODS	T061L
STRAINER	SR017
SNARES	SN1420I



Top-end projection with fat highs and mids.
STA1450MM



Thick snare tone with suppressed mid-tonality.
STA1465MM

STA1450MM	14" x 5"
SHELL	6 ply 5.4mm Maple
HOOPS	SuperHoop II (SH1410B/1410S)
LUGS	ARL55
TENSION RODS	SST5047
STRAINER	SR150
SNARES	SN1420D

STA1465MM	14" x 6.5"
SHELL	6 ply 5.4mm Maple
HOOPS	SuperHoop II (SH1410B/1410S)
LUGS	ARL65
TENSION RODS	SST5047
STRAINER	SR150
SNARES	SN1420D

THE SR017 STRAINER

Simple and effective, the SR017 is a Pearl standard for effortless snare switching and sensitivity control. Its smooth lever action and fine-tuning knob let you dial in the right amount of snare wire saturation to suit your personal sound.

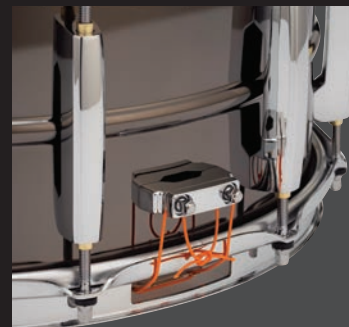

ON

OFF

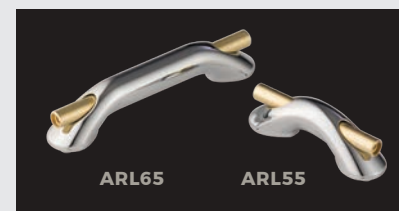

ARL65

ARL55

The stylish Arch-Tube Lug features a low contact design with separate self-aligning swivel nuts for pristine tuning across the head and reduced binding within the lug. (U.S. Patent #9502013)



The Baritone Snare, low end tone with top end snap.
STA1550MH

STA1550MH	15" x 5"
SHELL	4 Ply 5mm African Mahogany w/ Maple Reinforcement Rings
HOOPS	SuperHoop II (SH1510B/1510S)
LUGS	ARL55
TENSION RODS	SST5047
STRAINER	SR150
SNARES	SN1520I

Sensi Tone Premium's selection of refined percussion instruments are sure to be first call drums for the stage, studio, and beyond.

SIGNATURE

CAPTURING THE EXCLUSIVE SOUND OF DRUMMING LEGENDS

MATT HALPERN



MH1460B		14" x 6"
SHELL	1.5mm Black Powder-Coated Brass	
HOOPS	MasterCast (DCB1410/1410S)	
LUGS	STL55MH/B	
TENSION RODS	SST5052	
STRAINER	SR150	
SNARES	SN1420I	
FINISHES	Custom Black	



VENTS AH03 (x3)

IAN PAICE



IP1465		14" x 6.5"
SHELL	Beaded Steel Shell	
HOOPS	SuperHoop II (SH1410B/1410S)	
LUGS	TB65 w/ TL20	
TENSION RODS	SST5042 Stainless Steel (10)	
STRAINER	SR017	
SNARES	SO22N	
FINISHES	Chrome-Plated	



BRIAN FRASIER-MOORE



BFM1455S/C		14" x 5.5"
SHELL	12-Ply, 15mm Gum/Maple/Gum	
HOOPS	MasterCast (DC1410/DC1410S)	
LUGS	CL55	
TENSION RODS	T062	
STRAINER	SR150	
SNARES	SN1442I	
FINISHES	Gloss Gumwood Naturalburst	



JOEY JORDISON



JJ1365N		13" x 6.5"
SHELL	Steel/Black Shell	
HOOPS	SuperHoop II (SHB1308/1308S)	
LUGS	CL65B	
TENSION RODS	SST5047 Stainless Steel (10)	
STRAINER	SR017/B	
SNARES	SO29N	
FINISHES	Custom Black	



DENNIS CHAMBERS



DC1450S/N		14" x 5"
SHELL	Cast Aluminum: 3mm w/ 2mm R. Rings	
HOOPS	SuperHoop II (SHN1412B/1408S)	
LUGS	STL100 (12 over 8)	
TENSION RODS	SST5047 Stainless Steel (20)	
STRAINER	SR020 Multi-Trace Strainer System	
SNARES	SN1420I	
FINISHES	Black Nickel Shell w/ Nickel Hardware	



OMAR HAKIM



OH1350		13" x 5"
SHELL	6 ply African Mahogany Shell	
HOOPS	2.3mm SuperHoop II (SH1308/1308S)	
LUGS	CL55	
TENSION RODS	SST5047 Stainless Steel (8)	
STRAINER	SR015 Gladstone Style	
SNARES	SO29N	
FINISHES	#140 Natural Mahogany	



HYBRID EXOTIC

SPACE-AGE PRECISION, TIMELESS TONE

For the ultimate in power and prestige. Shell choices include spun-composite, seamless Cast Aluminum, and Kapur/Fiberglass.

GLIDE-LOCK THROW-OFF SYSTEM Pearl's SR1000 Glide-Lock Strainer's locking throw-off lever and tension knob assures worry free, slip-free performance from all Hybrid Exotic Snare Drums. (U.S. Patent #7220905, #7301087, #7365256.)



DUOLUXE

THE WORLD'S FIRST INLAID BRASS SNARE DRUM

Pearl celebrates three-quarters of a century of iconic drum sounds with DuoLuxe, a modern take on our legendary Jupiter snare drum. This classic combination of a chrome-over-brass alloy shell and our trademark dual inverted shell beads is augmented with two finish bands of Nicotine White Marine Pearl inlay. This gives the shell a singular look and adds tonal nuance to its unbridled sound.



Quick, yielding snap with heavy midrange overtones.
HEP1450



Full-Spectrum snare body with thick bottom-end tonality.
HEP1465

HEP1450	14" x 5"
SHELL	VectorCast
HOOPS	SuperHoop II (SH1410B/1410S)
LUGS	STL100
TENSION RODS	SPT5047 (top) - SST5047 (bottom)
STRAINER	SR1000
SNARES	SN1420C

HEP1465	14" x 6.5"
SHELL	VectorCast
HOOPS	SuperHoop II (SH1410B/1410S)
LUGS	STL100
TENSION RODS	SPT5047 (top) - SST5047 (bottom)
STRAINER	SR1000
SNARES	SN1420C



Bold and crisp with short midrange overtone.
DUX1450BR



Fierce and centered mid-to-low sustain.
DUX1465BR

DUX1450BR	14" x 5"
SHELL	1mm Dual-Beaded Chrome/Brass
HOOPS	SuperHoop II (SH1410B/1410S)
INLAY	#405 Nicotine White Marine Pearl (x2)
LUGS	BSL55
TENSION RODS	SST5042
STRAINER	SR017
SNARES	SN1420I

DUX1465BR	14" x 6.5"
SHELL	1mm Dual-Beaded Chrome/Brass
HOOPS	SuperHoop II (SH1410B/1410S)
INLAY	#405 Nicotine White Marine Pearl (x2)
LUGS	BSL55
TENSION RODS	SST5055
STRAINER	SR017
SNARES	SN1420I



Dry, high-pitched crack with little overtone.
HEAL1450



Fat midrange focus without sacrificing volume.
HEAL1465

HEAL1450	14" x 5"
SHELL	Cast Aluminum: 3mm w/ 2mm R-Rings
HOOPS	SuperHoop II (SH1410B/1410S)
LUGS	STL100
TENSION RODS	SPT5047 (top) - SST5047 (bottom)
STRAINER	SR1000
SNARES	SN1420I

HEAL1465	14" x 6.5"
SHELL	Cast Aluminum: 3mm w/ 2mm R-Rings
HOOPS	SuperHoop II (SH1410B/1410S)
LUGS	STL100
TENSION RODS	SPT5047 (top) - SST5047 (bottom)
STRAINER	SR1000
SNARES	SN1420I



Articulate snare punch, best at higher tunings.
HEK1450



Lively blend of throaty snare holler and punchy projection.
HEK1465

HEK1450	14" x 5"
SHELL	6 ply 7.5mm Kapur w/ Inner Fiberglass
HOOPS	SuperHoop II (SH1410B/1410S)
LUGS	STL100
TENSION RODS	SPT5047 (top) - SST5047 (bottom)
STRAINER	SR1000
SNARES	SN1420D

HEK1465	14" x 6.5"
SHELL	6 ply 7.5mm Kapur w/ Inner Fiberglass
HOOPS	SuperHoop II (SH1410B/1410S)
LUGS	STL100
TENSION RODS	SPT5047 (top) - SST5047 (bottom)
STRAINER	SR1000
SNARES	SN1420D

SPIN-TIGHT™ TENSION RODS To maintain tuning tension across the batter head, all Hybrid Exotic snare drums feature Pearl's Spin-Tight tension rods. This elegantly simple innovation creates a tension rod-within-a-tension rod, that allows the rod to expand and lock into place within the swivel nut. Utilizing a special drum key, tunings can be controlled under high-impact play like never before.



Low, thunderous wallop with deep, solid playability.
HEK1480

HEK1480	14" x 8"
SHELL	6 ply 7.5mm Kapur w/ Inner Fiberglass
HOOPS	SuperHoop II (SH1410B/1410S)
LUGS	STL100
TENSION RODS	SPT5047 (top) - SST5047 (bottom)
STRAINER	SR1000
SNARES	SN1442D



STAVECRAFT

FEATURING THE EXCLUSIVE DADO-LOC JOINT

A startling addition to any pro drummer's soundscape, each StaveCraft shell starts from two layers of meticulously beveled solid Makha or ThaiOak staves. Dado-Loc, an old world principal exclusive to these snares, inserts a segment

of corresponding wood into the center Dado channel formed by each stave and increases total shell strength by 50%. This solid fusion of hardwoods is lathed to a perfectly round 25mm thickness for unparalleled volume and power.



Quick, tight high-range tonal power.
SCD1450TO



Sensitive, centered low-overtone drive.
SCD1465TO

SCD1450TO	14" x 5"
SHELL	25mm Dual Thai Oak Stave w/ Makha DadoLoc
HOOPS	MasterCast (DC1410/DC1410S)
LUGS	STL55L
TENSION RODS	SST5042
STRAINER	SR150 ClickLock
SNARES	SN1420I

SCD1465TO	14" x 6.5"
SHELL	25mm Dual Thai Oak Stave w/ Makha DadoLoc
HOOPS	MasterCast (DC1410/DC1410S)
LUGS	STL65
TENSION RODS	SST5047
STRAINER	SR150 ClickLock
SNARES	SN1420I



Cracking tonal pop with short midrange hum.
SCD1450MK



Thick, cavernous sonic body with cutting punch.
SCD1465MK

SCD1450MK	14" x 5"
SHELL	25mm Dual Makha Stave w/ Thai Oak DadoLoc
HOOPS	MasterCast (DC1410/DC1410S)
LUGS	STL55L
TENSION RODS	SST5042
STRAINER	SR150 ClickLock
SNARES	SN1420I

SCD1465MK	14" x 6.5"
SHELL	25mm Dual Makha Stave w/ Thai Oak DadoLoc
HOOPS	MasterCast (DC1410/DC1410S)
LUGS	STL65L
TENSION RODS	SST5047
STRAINER	SR150 ClickLock
SNARES	SN1420I

UTILITY

VERSATILE DRUMS FOR SECONDARY EFFECTS

MODERN UTILITY snare drums are vital instruments. Well-appointed tools of the trade crafted for the informed, current drummer to make the gig great. Priced for the active working player, Modern Utility snares are available in both 100% Maple and Beaded Steel. Flexible enough to add to any setup and strong enough to stand up to constant play, each model has a cool, versatile vibe. Featuring our CL arch lugs and smooth SR700 snare strainer for precise tunability.



See Korn drummer Ray Luzier's performance test of each Modern Utility snare at pearldrums.com



MUS1480M/C



MUS1410FM/C

Leg Brackets: FTB07 (x3)



MUS1455M/C



MUS1465M/C



MUS1350M/C



MUS1270M/C

MODERN UTILITY

MUS1480M/C	14" x 8"
SHELL	6 Ply Maple (7.5mm)
HOOPS	Super Hoop II (SH1006/1006S)
LUGS	CL65
TENSION RODS	SST5035 (12)
STRAINER	SR018
SNARES	S032N
FINISHES	#224 Matte Natural, #227 Satin Black

MUS1410M/C	14" x 10"
SHELL	6 ply Maple (5.4mm)
HOOPS	1.6mm Steel (RH1408/1408S)
LUGS	CL100
TENSION RODS	TR5052 (16)
STRAINER	SR017
SNARES	SNW1420
FINISHES	Satin Brown (#220)

MUS1455M/C	14" x 5.5"
SHELL	6 ply Maple (5.4mm)
HOOPS	1.6mm Steel (RH1408/1408S)
LUGS	CL55
TENSION RODS	TR5052 (16)
STRAINER	SR700
SNARES	SNW1420
FINISHES	#224 Matte Natural, #227 Satin Black

MUS1465M/C	14" x 6.5"
SHELL	6 ply Maple (5.4mm)
HOOPS	1.6mm Steel (RH1408/1408S)
LUGS	CL65
TENSION RODS	TR5047 (16)
STRAINER	SR700
SNARES	SNW1420
FINISHES	#224 Matte Natural, #227 Satin Black

MUS1350M/C	13" x 5"
SHELL	6 ply Maple (5.4mm)
HOOPS	1.6mm Steel (RH1308/1308S)
LUGS	CL55
TENSION RODS	TR5047 (16)
STRAINER	SR700
SNARES	SNW1316
FINISHES	#224 Matte Natural, #227 Satin Black

MUS1270M/C	12" x 7"
SHELL	6 ply Maple (5.4mm)
HOOPS	1.6mm Steel (RH1206/1206S)
LUGS	CL65
TENSION RODS	TR5057 (12)
STRAINER	SR017
SNARES	SNW1216
FINISHES	#224 Matte Natural, #227 Satin Black

COLLABORATION

CASEY COOPER @COOP3RDRUMM3R



THE IGNITER To capture the searing energy of drumming for a new generation of players, Pearl collaborated with viral video drummer Casey Cooper to create The Igniter. Specifically created to instantly improve the sound of any student drum kit, it's a fantastic value to keep the fire of drumming burning bright!

EFFECTS

CC1450S/C	14" x 5"
SHELL	6-ply 6.8mm Poplar/Maple
HOOPS	1.6mm Steel (RH1408/1408S)
LUGS	CL55
TENSION RODS	TR5047 (16)
STRAINER	SR700
SNARES	SNW1420
FINISHES	Artisan II Flame Wrap



EFFECTS SNARES



M1060	10" x 6"
SHELL	6 Ply Maple (7.5mm)
HOOPS	Super Hoop II (SH1006/1006S)
LUGS	CL65
TENSION RODS	SST5035 (12)
STRAINER	SR018
SNARES	S032N



M1270	12" x 7"
SHELL	8 Ply Maple (10mm)
HOOPS	1.6mm Steel (RIM1208B/1208S)
LUGS	CL100
TENSION RODS	SST5047 Stainless Steel (16)
STRAINER	SR018
SNARES	S031N



SFS10/C31	10" x 4.5"
SHELL	6 Ply Poplar
HOOPS	1.6mm Steel (RIM1006RS/RIM1006RS)
LUGS	MSFL35
TENSION RODS	RSHT3240 (12)
STRAINER	SR02MSFL/SR02EMSFL
SNARES	SN10MSFL

PICCOLO



B1330	13" x 3"
SHELL	1.0mm Brass
HOOPS	1.6mm Steel (RIM1308B/1308S)
LUGS	CL05
TENSION RODS	T055 (16)
STRAINER	SR018
SNARES	S029N



S1330B	13" x 3"
SHELL	1.0mm Black-finish Steel
HOOPS	1.6mm Steel (RIM1308B/1308S)
LUGS	CL05
TENSION RODS	T055 (16)
STRAINER	SR018
SNARES	S029N



M1330	13" x 3"
SHELL	6ply Maple (7.5mm)
HOOPS	1.6mm Steel (RIM1308B/1308S)
LUGS	CL05
TENSION RODS	T055 (16)
STRAINER	SR018
SNARES	S029N

FIRECRACKER



FCP1250	12" x 5"
SHELL	8 ply Poplar (10mm)
HOOPS	1.6mm Steel (RIM1206/1206SL)
LUGS	CL50
TENSION RODS	T061L (12)
STRAINER	SR018
SNARES	S031



FCS1050	10" x 5"
SHELL	1.0mm Steel
HOOPS	1.6mm Steel (RIM1006/1006SL)
LUGS	CL50
TENSION RODS	T061L (12)
STRAINER	SR018
SNARES	S032

DEMON PEDALS

THE FASTEST, SMOOTHEST, MOST POWERFUL PEDALS IN THE WORLD

DRIVE	Direct Drive
FOOT BOARD	Duo-Deck Convertible
LINK ADJUSTMENT	Dual Position
BEATER	Control Core
TENSION ADJUSTMENT	Click-Lock
DRIVE BEARINGS	NiNja Low-Friction
PEDAL HEIGHT	Infinitely Adjustable
BEATER ANGLE	Infinitely Adjustable
CASE	Included



U.S. Patent #7579540

A choice of 2 positions for a finesse or power feel. Simply loosen the clamshell to change position.

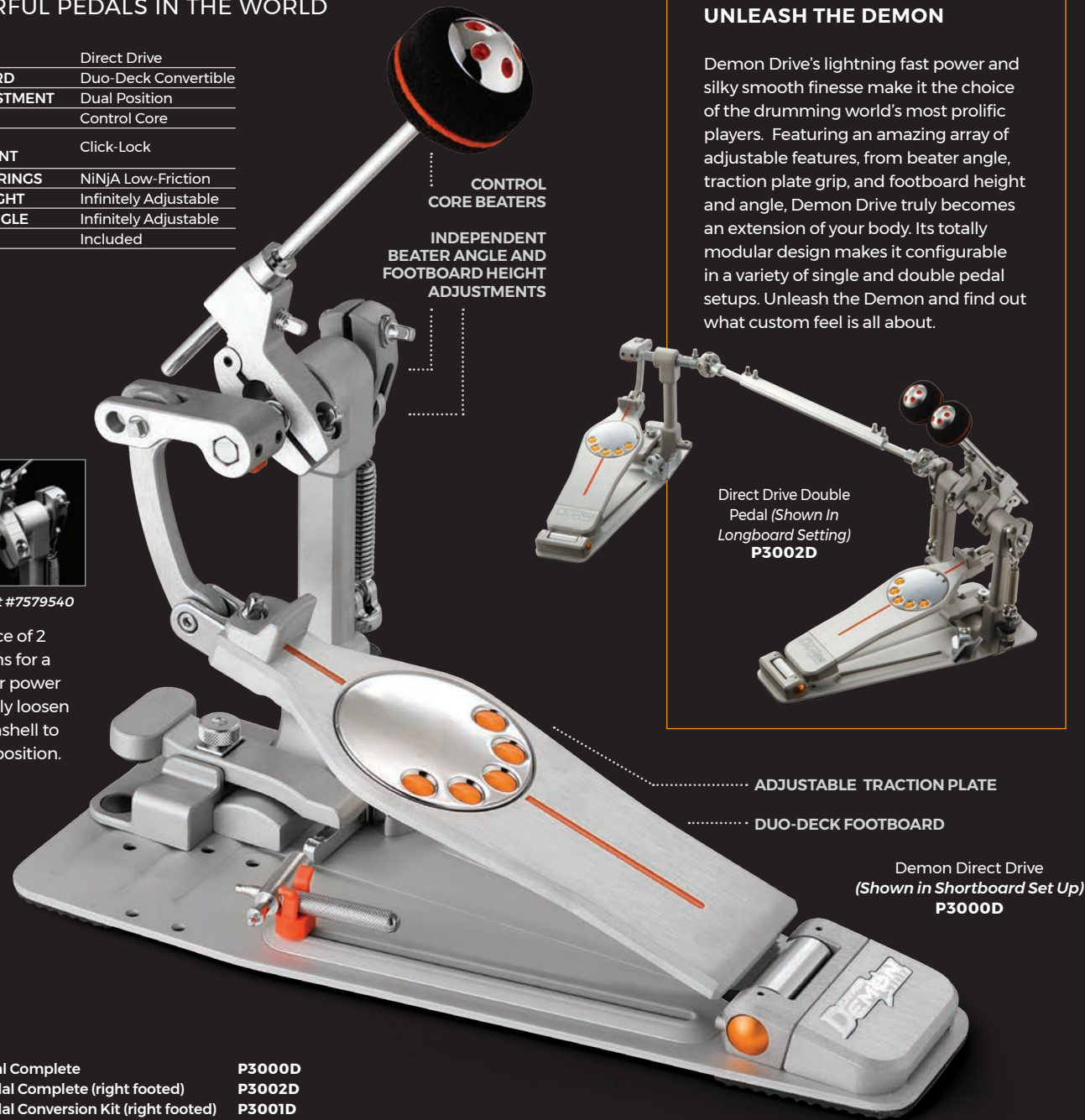

Single Pedal Complete	P3000D
Double Pedal Complete (right footed)	P3002D
Double Pedal Conversion Kit (right footed)	P3001D
Double Pedal Complete (left footed)	P3002DL

DEMON DRIVE

UNLEASH THE DEMON

Demon Drive's lightning fast power and silky smooth finesse make it the choice of the drumming world's most prolific players. Featuring an amazing array of adjustable features, from beater angle, traction plate grip, and footboard height and angle, Demon Drive truly becomes an extension of your body. Its totally modular design makes it configurable in a variety of single and double pedal setups. Unleash the Demon and find out what custom feel is all about.



Direct Drive Double Pedal (Shown In Longboard Setting) **P3002D**

Demon Direct Drive (Shown in Shortboard Set Up) **P3000D**



DEMON CHAIN

TRADITIONAL FEEL AND POWER OF A CHAIN

An innovative combination of Demon Drive speed and traditional chain drive feel, the Demon Chain's Perfect Circle cam delivers smooth, consistent response throughout the stroke for pinpoint accuracy and control. A high performance package for the driven power drummer.

Single Pedal Complete	P3000C
Double Pedal Complete (right footed)	P3002C
Double Pedal Conversion Kit (right footed)	P3001C
Double Pedal Complete (left footed)	P3002CL

EQUIPMENT FAILURE IS NOT AN OPTION, END OF STORY.

Pearl's hardware is LEGENDARY. So rugged, sure-footed, and built to last that we back it up with PEARL'S EXCLUSIVE Lifetime Warranty.

DRIVE	Ultralight Chain
FOOT BOARD	Duo-Deck Convertible
DRIVE CAM	Perfect Circle "Linear Response" Cam
BEATER	Control Core
TENSION ADJUSTMENT	Click-Lock
DRIVE BEARINGS	NiNja Low-Friction
PEDAL HEIGHT	Infinitely Adjustable
BEATER ANGLE	Infinitely Adjustable
CASE	Included

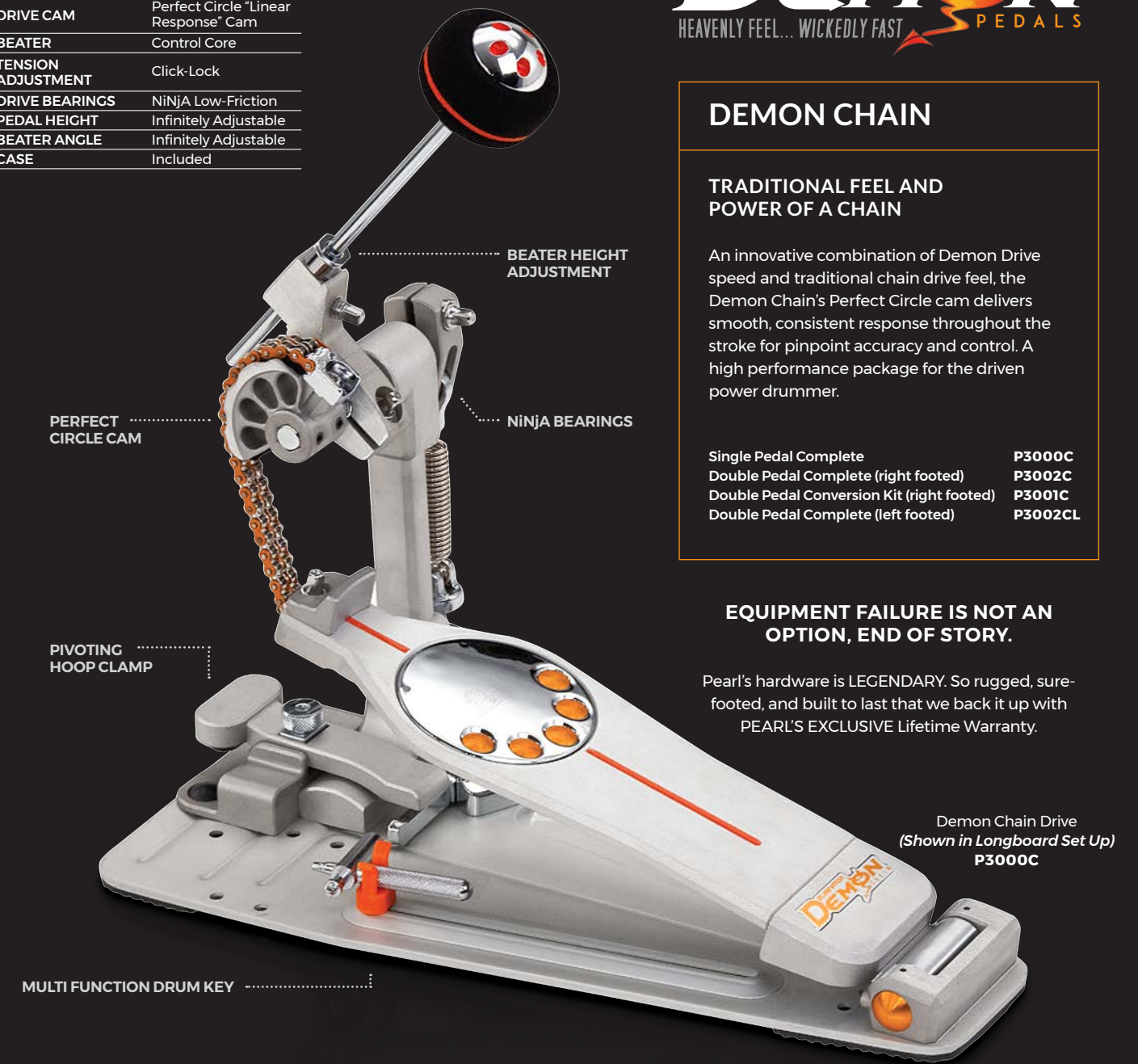

MULTI FUNCTION DRUM KEY

Demon Chain Drive (Shown in Longboard Set Up) **P3000C**



DIRECT LINK Dual position adjustment for LIGHT or HEAVY feel, creating a seamless link between your foot and the bass drum.

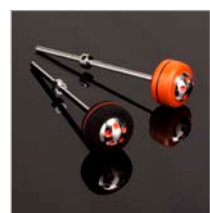

DEMON DRIVE BEATER w/ Control Core Elastomer Center. Reduces impact vibration. (U.S. Patent #7626108)



CLICK-LOCK Secures spring tension in high impact play. (U.S. Patent #7754953)



DUO-DECK FOOTBOARD The world's first convertible footboard can switch from a traditional shortboard to a longboard pedal in seconds. (U.S. Patent #7626107)



NINJA BEARINGS Designed for Pro Skateboarding, each bearing features micro-polished balls for minimal friction and unmatched speed.



PERFECT CIRCLE CAM Its racing inspired lines transfer energy from your foot into the head with minimal mass and maximum speed.

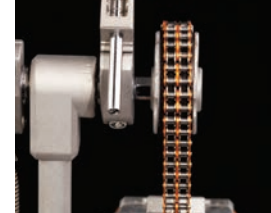

POWER CHAIN This ultra lightweight, dual linkage Chain features low friction rollers for power and dependability.



P3002C Chain Drive Double Pedal (Shown In Shortboard Setting)



Z-LINK DRIVE SHAFT Delivering the same precise action of the primary pedal in the secondary pedal, the Z-Link features hand assembled, CNC machined construction. Features Pearl's exclusive Zero Latency Universal Joints, and precision radial ball bearings.

ELIMINATOR: REDLINE

THE KEY TO ULTIMATE BASS DRUM PERFORMANCE



Eliminator Redline Single Pedal, Chain Drive
P2050C

CHOOSE A CAM REDLINE YOUR PERFORMANCE

The world's only pedal featuring the Patented Interchangeable Cam System, Eliminator: Redline's virtually unlimited tunability lets you lock in personally tuned feel, power, and speed. Like having four pedals in one, Redline pushes the boundaries of bass drum performance by fusing the power and flexibility of Pearl's original Eliminator with the fluid speed of our Demon series pedals.

DRIVE	Sprocketless Double Chain
FOOT BOARD	Redline Reversible Traction Plate
DRIVE BEARINGS	NiNjA Low-Friction
BEATER	Control Core Quadbeater
TENSION ADJUSTMENT	Click-Lock
BEATER ANGLE	Uni-Lock Infinitely Adjustable
POWERSHIFTER	Three Position
CASE	Included
HEEL PLATE HINGE	Zero Play (U.S. Patent #7179978)

P2050C



*Shown w/ Optional Red Cam

CHAIN OR BELT DRIVE

The sprocket-less double chain drive on the Eliminator Redline (P2050C) provides super smooth action with powerful and precise feel. The Eliminator Belt Drive model (P2050B) provides a very comfortable, natural feel similar to a direct-drive system.

ELIMINATOR REDLINE INTERCHANGEABLE CAM SYSTEM

Provides a choice of 6 different color-coded cams (4 included and 2 more optional). Quickly changes the power and feel of the pedal to suit your individual playing needs. Changing the cam is as simple as pushing the release button and snapping another in place.

BLACK CAMTBK	WHITE CAMTWT	BLUE CAMTBL	RED CAMTRD	PURPLE CAMPL	YELLOW CAMYL
Linear action cam	Oversized linear cam	Progressive cam	Radical progressive cam	Aggressive action cam (Optional)	Inverse action cam (Optional)

DRIVE	Sprocketless Double Chain
UNIVERSAL JOINT	Length Adjustable, Latency-Free
FOOT BOARD	Redline Reversible Traction Plate
DRIVE BEARINGS	NiNjA Low-Friction
BEATER	Control Core Quadbeater
TENSION ADJUSTMENT	Click-Lock
BEATER ANGLE	Uni-Lock Infinitely Adjustable
POWERSHIFTER	Three Position
HEEL PLATE HINGE	Zero Play (U.S. Patent #7179978)

P2052C

DRIVE	Sprocket-less Double Chain
FOOT BOARD	Redline Reversible Traction Plate
DRIVE BEARINGS	NiNjA Low-Friction
BEATER	Control Core Quadbeater
TENSION ADJUSTMENT	Click-Lock
BEATER ANGLE	Uni-Lock Infinitely Adjustable
POWERSHIFTER	Three Position
CASE	Included
HEEL PLATE HINGE	Zero Play (U.S. Patent #7179978)

P2050B

DRIVE	Sprocketless Double Chain
UNIVERSAL JOINT	Length Adjustable, Latency-Free
FOOT BOARD	Redline Reversible Traction Plate
DRIVE BEARINGS	NiNjA Low-Friction
BEATER	Control Core Quadbeater
TENSION ADJUSTMENT	Click-Lock
BEATER ANGLE	Uni-Lock Infinitely Adjustable
POWERSHIFTER	Three Position
HEEL PLATE HINGE	Zero Play (U.S. Patent #7179978)

P2052B



Eliminator Redline Double Pedal, Belt Drive
P2052B

Eliminator Redline Series pedals come standard with Custom Carry bags.

Eliminator Redline Double Pedal Chain Drive (Shown w/ Included Red Cam Attached)
P2052C



POWERSHIFTER FUNCTION By moving the foot board forward or back, our revolutionary PowerShifter function provides 3 positions to fine tune the power and feel of the pedal. Instantly change the drive angle leverage to create a light, regular, or strong feel. U.S. Patent #5574237



NINJA BEARINGS Developed by skateboarding engineers for the ultimate in fast, quiet performance, NiNjA Bearings incorporate state of the art micropolished steel balls for incredibly fast and smooth performance.



ZERO PLAY HINGE Our proprietary stainless steel hinge provides maximum freedom of motion for blazing speed and prevents play between the footboard and heel. U.S. Patent #7179978



ROLLER HOOP CLAMP w/ Side Mount Adjustment. Quickly adapts to a wide range of hoop thicknesses for the smoothest, most secure grip possible. Easy side access to the hoop clamp makes set up and tear down a breeze.



INDEPENDENT TRACTION GRIPS Eliminator Redline's redesigned pedalboard features Pearl's exclusive reversible Traction Plate insert, allowing individual traction grip configuration to suit your exact playing requirements.



CLICK-LOCK SPRING ADJUSTMENT w/ NEW Rotor Tension Cradle. Secures spring tension in high impact play. The counter spring adjustment's rolling cradle allows the spring to pivot with each stroke for less resistance. U.S. Patent #7754953



THE CONTROL CORE QUADBEATER Provides four beater surfaces (two hard plastic, two felt) with the added feel of the vibration-free Control Core elastomer center. U.S. Patent #7626108



UNI-LOCK BEATER ANGLE CAM Grips the axle a full 360 degrees, allowing infinite beater angle adjustments. Floating Spring Pendulum design is perfectly centered on the clamp for full bearing movement and maximum smoothness.

ELIMINATOR SOLO

FLY SOLO AND SET YOUR FEET FREE

ELIMINATOR SOLO: BLACK

Delivering blinding speed and powerful performance, Eliminator Solo bass drum pedals put the fleet footed player in control with all the gliding velocity that made Pearl pedals revolutionary. These no nonsense, streamlined Eliminator models deliver singular, resistance free feel for effortless play and driving performance.

The Solo: Black pedal's even, slightly weighted feel delivers just the right amount of resistance without slowing your stroke - for increased power and less muscle fatigue.

DRIVE	Sprocketless Double Chain
FOOT BOARD	Brushed Aluminum
POWERSHIFTER	Three Position
BEATER ANGLE	Uni-Lock Infinitely Adjustable
ROLLER HOOP CLAMP	Side Mount Adjustment
TENSION ADJUSTMENT	Click-Lock
BEATER	Control Core DuoBeater

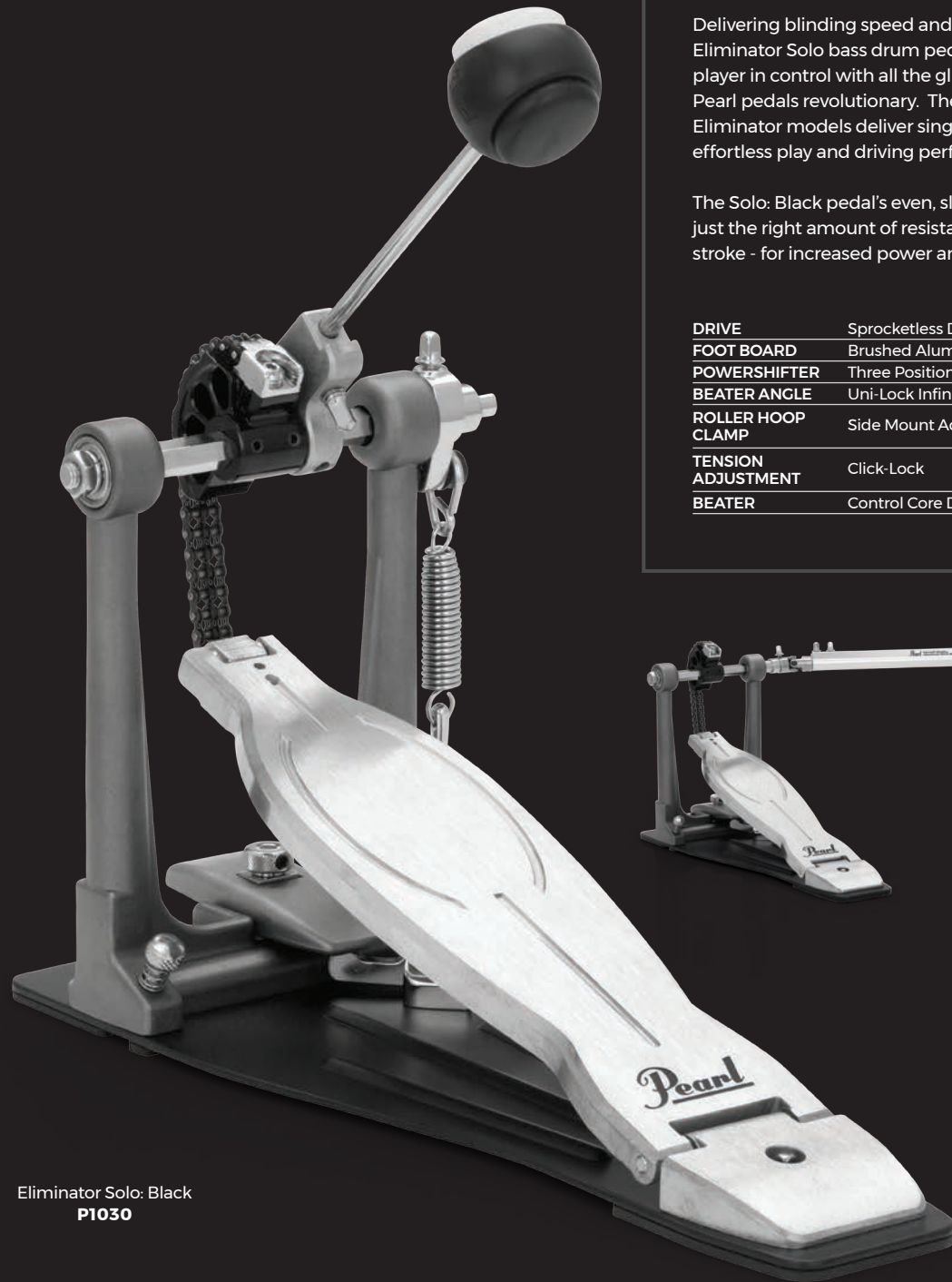

Eliminator Solo: Black P1030



Eliminator Solo: Black Double Pedal P1032

ELIMINATOR

**SINGULAR FEEL.
ELIMINATOR SPEED.
PRICED TO PERFORM.**

ELIMINATOR SOLO: RED

Delivering accurate speed and focused performance, the Eliminator Solo: Red bass drum pedal delivers no-nonsense Eliminator feel for the technically decisive player.

Focusing the drive on the accurate feel of the Radical Progressive Action of Eliminator: Redline Red Cam, its shape allows the double chain to better match the motion of your foot. This means smooth movement at the bottom of the stroke with an accelerated PUSH at the top, and quick rebound for reactive doubles.

DRIVE	Sprocketless Double Chain
FOOT BOARD	Brushed Aluminum
POWERSHIFTER	Three Position
BEATER ANGLE	Uni-Lock Infinitely Adjustable
ROLLER HOOP CLAMP	Side Mount Adjustment
TENSION ADJUSTMENT	Click-Lock
BEATER	Control Core QuadBeater



Eliminator Solo: Red P1030R

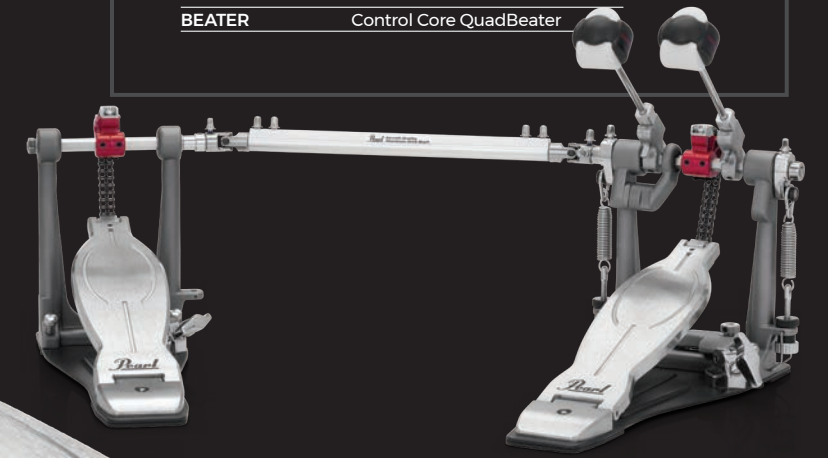

Eliminator Solo: Red Double Pedal P1032R



CONTROL CORE DUOBEATER

Provides hard and soft beater surfaces with the added feel of the vibration free Control Core elastomer center. U.S. Patent #7626108

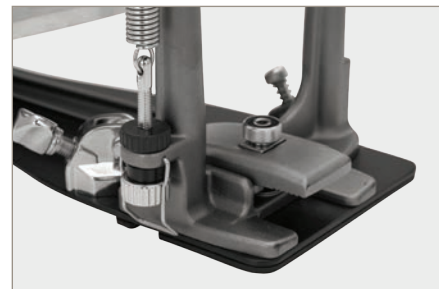

ROLLER HOOP CLAMP

Features side mount adjustment for easy set-up and tear down. Quickly adapts to a wide range of hoop thicknesses smooth, secure grip.

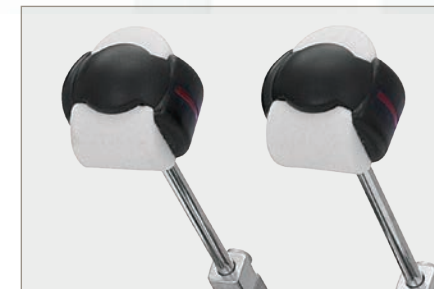

CONTROL CORE QUADBEATER

Provides four beater surfaces (two hard plastic, two felt) with the added feel of the vibration-free Control Core elastomer center. U.S. Patent #7626108

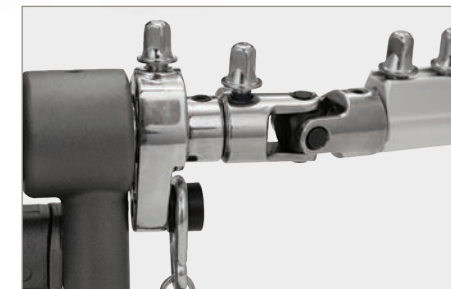

UNIVERSAL JOINT

All Eliminator Solo pedals come with Pearl's adjustable Universal Drive Joint, giving the secondary pedal the feel, power, and unrestrained feel of the main pedal.

P930 / P932 PEDALS

SPEED AND CONTROL FOR THE MASSES

SUPER SMOOTH, EXTREMELY FAST!

Merging quick rebound response of our flagship Demon Drive with the finely-tuned control of our award-winning Eliminator models, the P930 bass drum pedal offers high end performance at a player accessible price. Its longboard playing deck delivers a lighter feel for increased speed, and offers advanced performance control and tunability with two rotor cam options. The ultimate pedal for fast feet on a budget.

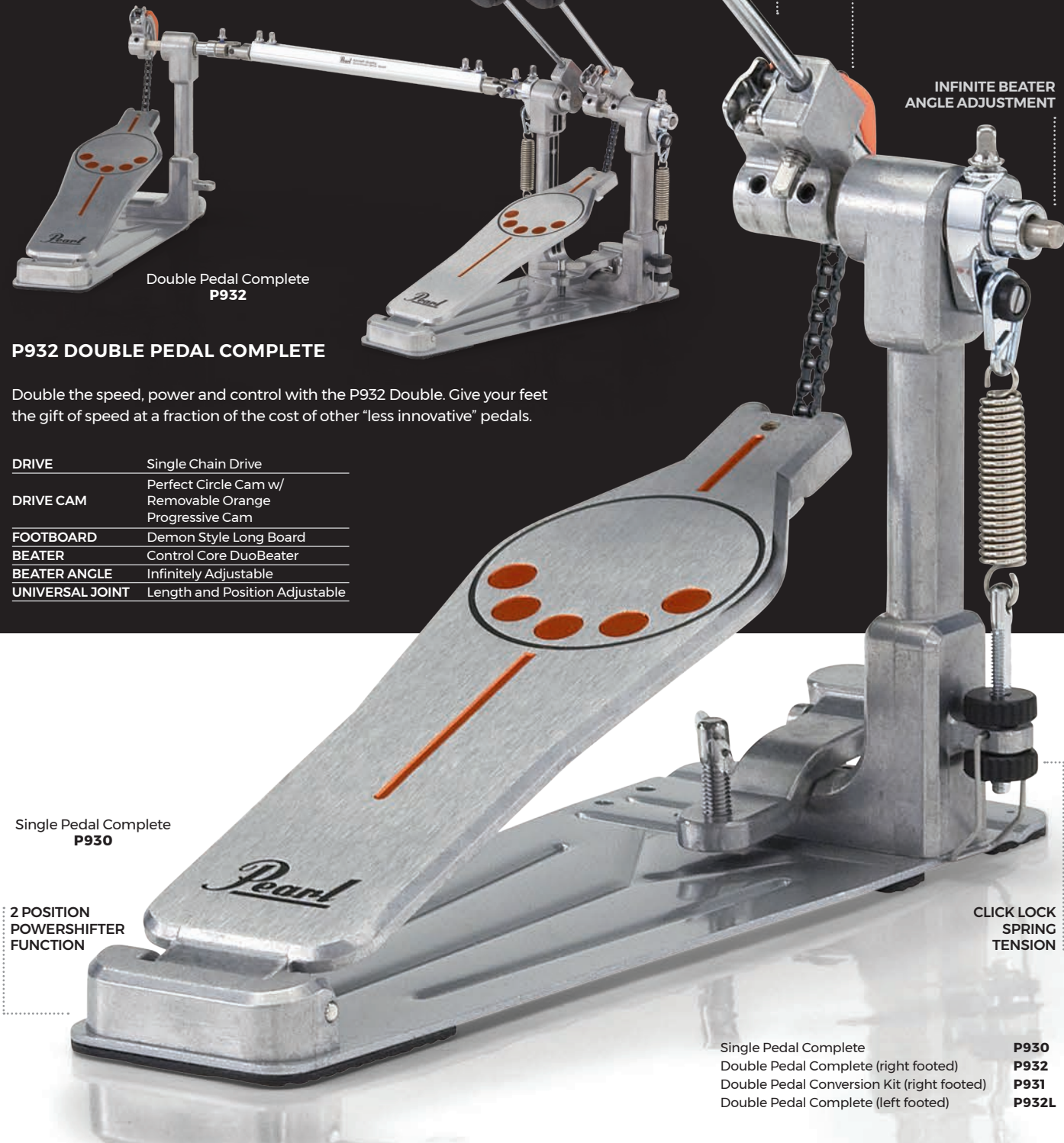

DRIVE	Single Chain Drive
DRIVE CAM	Perfect Circle Cam w/ Removable Eliminator- style Progressive Cam
FOOTBOARD	Demon Style Long Board
BEATER	Control Core DuoBeater
BEATER ANGLE	Infinitely Adjustable
SPRING TENSION	Click-Lock

P932 DOUBLE PEDAL COMPLETE

Double the speed, power and control with the P932 Double. Give your feet the gift of speed at a fraction of the cost of other "less innovative" pedals.

DRIVE	Single Chain Drive
DRIVE CAM	Perfect Circle Cam w/ Removable Orange Progressive Cam
FOOTBOARD	Demon Style Long Board
BEATER	Control Core DuoBeater
BEATER ANGLE	Infinitely Adjustable
UNIVERSAL JOINT	Length and Position Adjustable

Single Pedal Complete
P930

2 POSITION
POWERSHIFTER
FUNCTION

CLICK LOCK
SPRING
TENSION

Single Pedal Complete **P930**
Double Pedal Complete (right footed) **P932**
Double Pedal Conversion Kit (right footed) **P931**
Double Pedal Complete (left footed) **P932L**

ORANGE PROGRESSIVE CAM can be removed to reveal the Perfect Circle for further tunability to match your playing style. *U.S. Patent #6172291*



The P930 pedal is included as an upgrade in the 830 Series hardware pack and comes with Export and Export Lacquer drum sets.

CLICK-LOCK SPRING TENSION maintains perfect tension gig after gig. Set it and forget it. *U.S. Patent #7754953*

CONTROL CORE DUO BEATER

(U.S. Patent #7626108) utilizes an elastomer center to minimize vibration and features two unique playing surfaces (rounded felt and convex hard plastic surface) for quick-shifting tone and feel.



POWERSHIFTER FUNCTION

(U.S. Patent #5574237) further tunes the power, feel, and leverage of the pedal by shifting the chain angle forward for lighter feel, or back for increased power.

Comes standard with Perfect Circle and removable Orange Progressive Cams, for fully tunable performance and increased control.

P530 / P830

SPEED, POWER, AND VALUE

P530 DRUM PEDAL

With all the speed and function of a pro bass drum pedal at half the price, Pearl's P530 Bass Drum Pedal features a dual chain and Linear Action cam drive for smooth, traditional pedal action and speed.



The radius rod frame makes it highly portable for gigging, while features like a two surface DuoBeater and rotor tension axle clamp make it adaptable to virtually any feel or playing style.

Single Pedal Complete
P530

P830 DRUM PEDAL

Light in weight but not in features, the P830's Demon-style longboard increases playing surface for maximum leverage and speed. Its fully adjustable beater angle, Perfect Circle single chain cam, and DuoBeat two-surface beater deliver customizable feel for the player on the move.

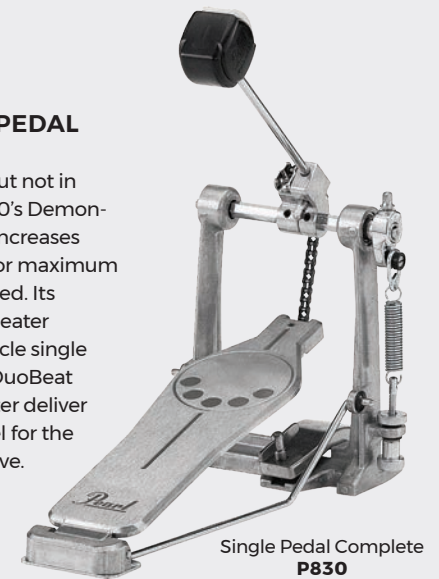

Single Pedal Complete
P830

HI-HAT STANDS

BIGGEST ADVANCEMENT IN TIME-KEEPING SINCE THE WRISTWATCH

H2050

Sharing many of the key characteristics of Pearl's Eliminator Redline bass drum pedals, 2050 Series Hi-Hat Stands deliver unparalleled versatility and customization in hi-hat pedal control. The world's-only hi-hat stand featuring the Interchangeable Cam System, 2050 Series stands' customizable options are designed to eliminate resistance, reduce fatigue, and increase performance.

BRIAN FRASIER-MOORE
Justin Timberlake



“Night in and night out, Pearl hardware keeps everything right where it should be, and without fail!”
- OKWA ANDREWS

OKWA ANDREWS
Brian's Tech

CLH930

- Closed Hi-Hat
- Uni-Lock Tilter
- Knurled Boom Arm
- UltraGrip Wing
- Nuts / Wing Bolts

CLA130

- Closed Hi-Hat
- Bass Drum Hoop Mounted
- Side-to-Side, Forward/Back Adjustable
- UltraGrip Wingnut
- Spring Adjustable Cymbal Spread

CLH70

- Closed Hi-Hat
- Multi-Angle Quickset Clamp
- Gearless UniLock Tilter
- UltraGrip Wingnut
- Spring Adjustable Wash



Pearl's Rapid Lock Super Grip's slip-proof clutch system features a patented 360° lock nut that provides vice-like clamping force for a super grip. (U.S. Patent #9355625)



The RH2050 Remote Hi-Hat's low-friction cable produces smooth, lag-free performance with the lightning-fast action of the PosiLink Twin Cam drive system. Fast, natural-feeling cymbal play is finally accessible virtually anywhere on the kit, or to facilitate multiple hi-hat system setups.



H1050

- Rapid Lock Clutch (U.S. Patent #9355625)
- Direct Pull Drive System
- Infinitely Adjustable Footboard Angle
- Double Braced Tripod w/ Swivel Function
- Spike/Rubber Tips
- Spring Tension Dial
- Hi-Hat Cup (U.S. Patent #7078606)
- Height range of 700-960mm



Features Eliminator Solo traditional footboard, double braced swiveling tripod, and gigging weight tubing for touring professionals.



Features Eliminator Solo traditional footboard, single braced swiveling tripod, and reduced weight for gigging professionals.



H830

- Demon Style Long Footboard (single color footboard)
- Double Braced Tripod w/ Swivel Function
- Height range of 610-910mm



Features an independent tripod positioned separately from the pedal frame, making it the only flat based hi-hat stand specifically for double pedals.

H150S

- Light Weight (6.30 lbs.)
- Stable Flat-Based Tripod
- Swivel Function Allows Easy Double-Pedal Positioning
- Direct-Pull Drive System
- Spring Tension Adjustment
- Redline Traction Plate Footboard
- Height range of 745-865mm

H2050

- Rapid Lock Super Grip Clutch (U.S. Patent #9355625)
- Hi-Hat Cup (U.S. Patent #7078606)
- Swiveling Legs
- Precision Spring Tension Dial
- PosiLink Twin Cam Drive System with Interchangeable Cams
- Traction Plate Footboard Convertible Spike/Rubber Feet (U.S. Patent #7371953)
- Footboard Docking Station
- PowerShifter
- Height Range of 750-1030mm

RH2050

- Rapid Lock Clutch (U.S. Patent #9355625)
- Direct Pull Drive System
- Infinitely Adjustable Footboard Angle
- Double Braced Tripod w/ Swivel Function
- Spike/Rubber Tips
- Spring Tension Dial
- Hi-Hat Cup (U.S. Patent #7078606)



INDEPENDENT TRACTION GRIPS features Pearl's exclusive reversible Traction Plate and individual traction grips, configurable to suit your individual taste.

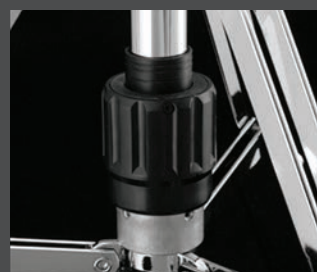

H2050 PRECISION SPRING TENSION DIAL allows perfect tension control for fine-tuned response.



H1050 PEDAL HEIGHT ADJUSTMENT The infinite footboard angle adjustment featured on the H2050 and H1050 allows precise height matching in multi-pedal setups.



CLAMSHELL CLAMP The H2050, H1050, H1030, H1030S, and H930 Hi-Hat Stand uses beefy 1" tubing and clamshell clamps with built in memory locks for superior rigidity.



H130 positions your hi-hat next to your bass pedal in double bass set-ups for effortless transitions between pedals.



H930 HI-HAT STAND H930 Hi-Hat Stand features our Demon style longboard, double braced tripod w/ swivel function, and precision tension dial.



H830 HI-HAT STAND H830 Hi-Hat Stand is standard equipment with our Export series and offers a monochromatic Demon Style longboard design and swivel tripod.



H150S* FLAT-BASED SWIVELING HI-HAT The H150S independent tripod is positioned separately from the pedal frame making it the only flat-based hi-hat stand with swiveling legs.

SNARE STANDS

EVERY SNARE SHOULD BE SO LUCKY

No matter the gig or the drum, Pearl has a stand to accommodate both with security, high function, and chameleon-like diversity.



S1030
CyroLock Tilter: infinite angle adjustability
Adjustable Snare Basket: Fits Snares 10" - 16"
Air Suspension Rubber Tips (U.S. Patent #6710236)
Trident Tripod
Height Range of 480-700mm
Oversize Super Grip Rubber Feet



S1030D
Low Position Snare Stand (Height Range: 360-570mm)
CyroLock Tilter: infinite angle adjustability
Adjustable Snare Basket: Fits 10" to 16" drums
Air Suspension Rubber Tips (U.S. Patent #6710236)
Trident Tripod
Oversize Super Grip Rubber Feet



S930
Uni-Lock Tilter
Air Suspension Rubber Tips (U.S. Patent #6710236)
Double Braced Trident Style Tripod
Fits Snares 10" - 14"
Height Range of 450-670mm
Also available as S930S drop basket version



S930D
Uni-Lock Tilter
Air Suspension Rubber Tips (U.S. Patent #6710236)
Double Braced Trident Style Tripod
Fits Snares 10" - 14"
Height Range of 360-570mm



S930S
Uni-Lock Tilter
Air Suspension Rubber Tips (U.S. Patent #6710236)
Single Braced Trident Style Tripod
Fits Snares 10" - 14"
Height Range of 420-610mm



S830
Uni-Lock Tilter
Double Braced Tripod
Fits Snares 13" - 14"
Height Range of 440-650mm
Standard with Export Series drums, perfect for local gigging and easy transport



S150S
Light Weight (5.18 lbs.)
Stable Flat-Based Tripod
Gearless Uni-Lock Basket Tilter
Convertible Tripod or Flat-Based Legs
Instantly convertible from flush-based to standard tripod



S1030 SNARE STAND GYROLOCK Our premier S1030 model features Pearl's 360 degree infinitely adjustable CyroLock tilter for ease-of-use and pinpoint positioning.



S1030 SNARE BASKET The Pearl S1030 Snare Stand adjusts to fit virtually any size snare from 10" to 16". The Air Suspension rubber tips securely cradle your prized snares while allowing them to fully resonate. (U.S. Patent #6710236)



S930D SNARE BASKET The S930D Snare Stand is a shorter version of the S930 Snare Stand, and is built to comfortably accommodate deeper snare drums.

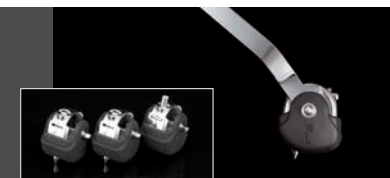

SPIKED / RUBBER FEET (Sold Separately) Our CVT300/3 Push Button Spiked/Rubber Feet come in pack of 3 to retrofit on any of our 1030 Series hardware for sure-footed performance on any terrain. (U.S. Patent #7371953)

DRUM THRONES

SOUND ERGONOMICS

Essential for extended and efficient performance, the right throne will prevent fatigue and promote great form and posture to keep you playing your best, night after night. Pearl thrones feature advanced ergonomic design and a selection of computer-tempered cushion tops to provide support and ease joint pressure during long sessions.

MULTI-CORE FOAM TECHNOLOGY: Roadster thrones now feature multiple layers of varied density foam which combine for a better playing foundation and improved feel.



D3500BR
Saddle-Style, Multi-Core Foam Cushion
Detachable Backrest Mounts via Single Knob
Lock/Spin System: Reversible StopLock allows cushion to be secured in place or free spinning depending on preference.
Height Range of 495-665mm



D3500
Saddle-Style, Multi-Core Foam Cushion
Accepts Optional Backrest
Lock/Spin Reversible StopLock System
Height Range of 495-665mm



D1500TGL
15" Trilateral Multi-Core Foam Cushion
Option of a Saddle or Round top feel.
Accepts Optional Backrest
Gas Lift Height Adjustment
Lightweight Aluminum Struts:
Solid support with easier transport
Height Range of 495-695mm



D1500RGL
15" Round Multi-Core Foam Cushion
Accepts Optional Backrest
Gas Lift Height Adjustment
Lightweight Aluminum Struts
Height Range 495-695mm



D1500SP
15" Vented Round Seat
Multi-Core Foam Donut Cushion
Accepts Optional Backrest
Built-In Shock Absorber Post w/ Adjustable Spring Tension
Lock/Spin Reversible StopLock System
Height Range of 525-630mm



D1500
15" Vented Round Seat
Multi-Core Foam Donut Cushion
Accepts Optional Backrest
Lock/Spin Reversible StopLock System
Height Range 495-665mm



D1500S
15" Vented Round Seat
Multi-Core Foam Donut Cushion
Accepts Optional Backrest
Lock/Spin Reversible StopLock System
Height Range 445-615mm



DTBR1535
12.5" x 7" Optional Backrest
Formfitting and Breathable
Removable
Dual Axis Adjustability



D930
Round Vinyl Cushion
Double Braced Legs
Height Range of 470-660mm



D790
Round Vinyl Cushion
Double Braced Legs
Height Range of 430-650mm



D730S
Round Vinyl Cushion
Single Braced Tripod
Height Range of 405-605mm



D50
Round Vinyl Cushion
Double Braced Tripod
Height Range of 495 - 620mm

CYMBAL STANDS

WELCOME TO BOOM TOWN

FOR EVERY CYMBAL, THERE IS A PLACE.

Advancing Drum Hardware for Serious Working Drummers since 1946. Through constant setup, teardown, performance, practice, and transport, Pearl has you covered with cymbal stand solutions that are ready to endure constant abuse and keep going.

“ Pearl hardware is literally the only hardware that you'll ever have to buy and it's all backed by their incredible lifetime warranty! ”

- TRACY BROUSSARD
Blake Shelton



CLAMSHELL designed Die Cast joint on 2030, 1030, 930 series Boom and Straight cymbal stands, provides superhuman clamping force. Set your position, lock it down and wall away.

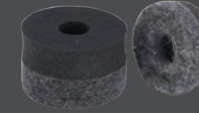

REVERSIBLE FELT / FOAM CYMBAL WASHERS allow four-way control of cymbal "ring" by mixing and matching the "hard" and "soft" surfaces of the washers.



830 SERIES STANDS offer lighter weight while incorporating many of the 1030 series designs. The tripod uses Trident style design with double braced legs. Large easy to use wingnuts and lateral struts for optimal stability.

The most technically advanced boom stand ever devised. Perfect for studio or live applications.

Reversible Felt/
Foam Washer



BC2030	BC1030C	B1030	BC930
CyroLock Tilter	CyroLock Tilter	CyroLock Tilter	Uni-Lock Tilter
WingLoc	WingLoc	WingLoc	Plastic Wingnut
Reversible Cup Washer w/ O-ring	Reversible Cup Washer w/ O-ring	Reversible Cup Washer w/ O-ring	Plastic Cymbal Cup
Die Cast Joint w/ Stop Lock	Convertible Boom Tilter	Die Cast Joint	Die Cast Joint
Trident Tripod	Trident Tripod	Trident Tripod	Trident Style
Double Braced Legs	Double Braced Legs	Double Braced Legs	Convertible Boom Tilter
Built in Percussion Post	Built in Percussion Post	Built in Percussion Post	Double Braced Leg
Nodal Point Resonance Enhancing System	Reversible Felt/ Foam Washer	Reversible Felt/Foam Washer	Height Range of 830-1800mm
Height Range of 800-2150mm	Height Range of 820-1900mm	Height Range of 820-1900mm	

Reduced weight for easy gigging transport.

Offers lighter weight with advanced appointment designs.

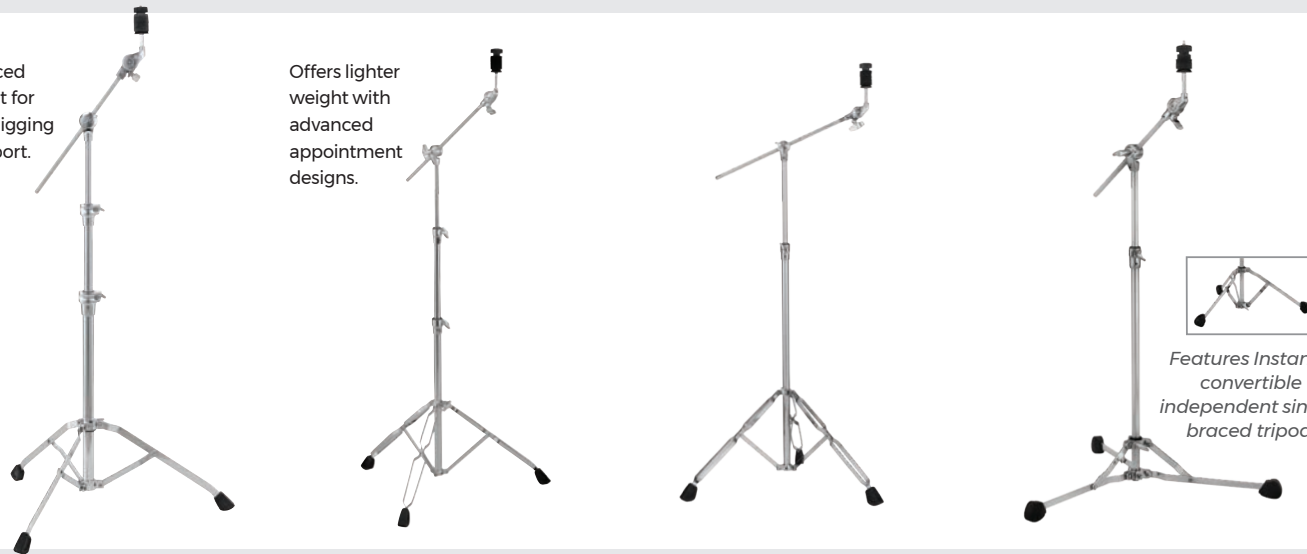

BC930S	BC830	BC820	BC150S
Uni-Lock Tilter	Uni-Lock Tilter	Uni-Lock Tilter	Light Weight (5.42 lbs.)
Plastic Wingnut	Plastic Wingnut	2 Section Stand	Uni-Lock Tilter
Plastic Cymbal Cup	Plastic Cymbal Cup	Plastic Wingnut	Convertible Single-Braced Tripod
Die Cast Joint	Die Cast Joint	Plastic Cymbal Cup	Convertible Boom Tilter
Trident Tripod w/ Single Braced Legs	Convertible Boom Tilter	Die Cast Joint	Plastic Wingnut and Cymbal Cup
Convertible Boom Tilter	Double Braced Legs	Convertible Boom Tilter	Reversible Felt/Foam Washer
Height Range of 780-1800mm	Height Range of 780-1480mm	Double Braced Legs	Height Range of 780-1300mm
		Height Range of 900-1740mm	

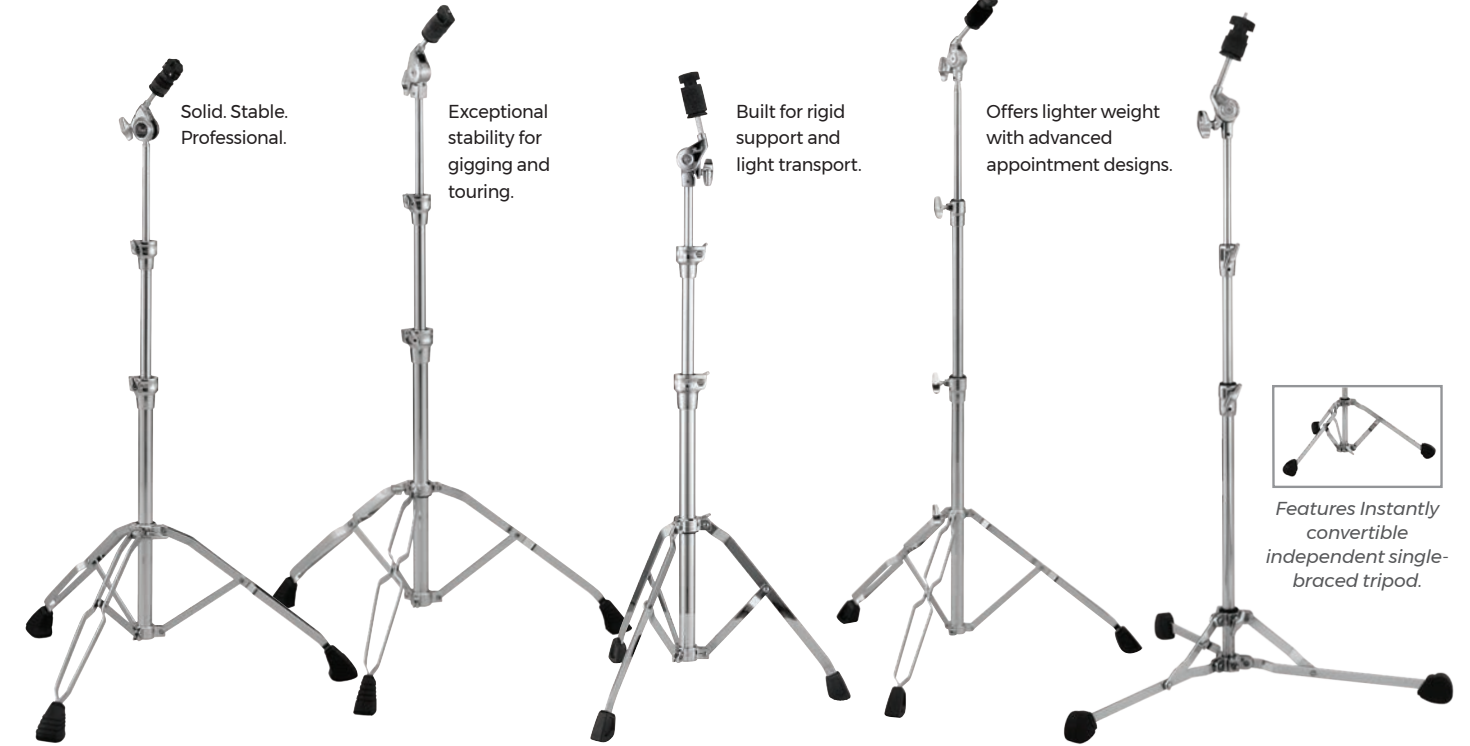

C1030	C930	C930S	C830	C150S
CyroLock Tilter	Uni-Lock Tilter	Uni-Lock Tilter	Uni-Lock Tilter	Light Weight (4.80 lbs.)
WingLoc	Plastic Wingnut	Plastic Wingnut	Plastic Wingnut	Uni-Lock Tilter
Reversible Cup Washer w/ O-ring	Plastic Cymbal Cup	Plastic Cymbal Cup	Plastic Cymbal Cup	Convertible Single-Braced Tripod
Die Cast Joint	Die Cast Joint	Die Cast Joint	Die Cast Joint	Plastic Wingnut and Cymbal Cup
Trident Tripod	Trident Style	Trident Style	Double Braced Legs	Reversible Felt/Foam Washer
Double Braced Legs	Double Braced Legs	w/ Single Braced Legs	Height Range of 720-1480mm	Height Range of 670-1350mm
Built in Percussion Post	Height Range of 760-1500mm	Height Range of 780-1480mm		
Height Range of 770-1530mm				

LIFETIME WARRANTY

Your hardware has to work as hard you do, and Pearl's strong, gig ready stands and appointments are ready for the job.

Featuring world class design and sophisticated, road proven refinements, Pearl Hardware is made to stand up to all the impact the gig can dish out, and backed by the Industry's only Lifetime Warranty.



THE TRIDENT TRIPOD

uses a full 360° of clamping force via the hinged collar. The inner tube rests in a nylon bushing to prevent metal to metal contact. Heavy duty legs feature lateral bracing for superior ultra quiet rigidity.



REVERSIBLE CUP WASHER w/ O-RING

(U.S. Patent #6940006) Specially designed to "float" normally or "lock" to prevent noise during recording.



WINGLOC Quick Release Wing Nut (U.S. Patent #6884015) Secure, adjustable, spring loaded cymbal nuts for quick set up and tear down.



NODAL POINT MARKINGS

Pearl's BC2030 features markings on the telescopic tubes that allow cymbals to achieve better clarity and sustain when the tubes are positioned at their respective Nodal Points. (U.S. Patent #9070348)



CYROLOCK TILTERS

are infinitely adjustable and provide 360 degree range of motion for precise positioning with one-step convenience.

ICON RACK SYSTEM

THE ORIGINAL DRUM RACK, EXPANDED

RACKS Preconfigured single and three-sided rack packages the upgraded rotating support foot.



Developed in 1983 with legendary Toto drummer Jeff Porcaro, Pearl's original DR1 Drum Rack was the first freestanding, frame based drum support system available.

Now, Pearl expands the **ICON** (short for Independent **CONTROL**) Rack system with a fresh selection of upgrades and high function mounting options.

3-Sided Rack (*also available DR008 Expansion Bar)
DR80

INCLUDES	(4) PC8 Pipe Clamps
RACK BAR	Black Anodized Aluminum 38mm Square, 91cm Length
RACK LEG	Black Anodized Aluminum 1.5" Diameter, 70.5cm Height



Single Drum Rack, Straight
(w/ PCX100X2 & PCL100X2)
DR511

MAIN SUPPORT RAIL	Brushed Aluminum, 40mm Square
MOUNTING CLAMPS	PCX100 Clamps (x2) Fits 1/2" to 1 1/8"
RACK RAIL LENGTH	38" (From Center of Right to Left Clamp) 36" (Usable Area)
RACK PIPE/LEG	Steel 1.5" / 3.8cm Diameter, 34" / 86.5cm Height
SUPPORT FOOT	Rotating 1.5" Round w/TLJ200 T-Clamp (P38475TA)
PIPE CLAMPS	PCL100 (x2) Accepts 7/8" Diameter Arms



Single Drum Rack, Curved
(w/ PCX100X2 & PCL100X2)
DR511C

MAIN SUPPORT RAIL	Brushed Aluminum, 40mm Square
MOUNTING CLAMPS	PCX100 Clamps (x2) Fits 1/2" to 1 1/8"
RACK RAIL LENGTH	46" (From Center of Right to Left Clamp / 44" (Usable Area)
RACK PIPE/LEG	Steel 1.5" / 3.8cm Diameter, 34" / 86.5cm Height
SUPPORT FOOT	Rotating 1.5" Round w/TLJ200 T-Clamp (P38475TA)
PIPE CLAMPS	PCL100 (x2) Accepts 7/8" Diameter Arms



Curved Drum Rack Expansion Bar
w/ Support Leg
DR511CE

RACK RAIL	Pearl 40mm Square Anodized Aluminium
SUPPORT LEG/FOOT	34"x2.5" Round Chrome w/ P38475TA Rotating Foot
USABLE RAIL AREA	44" (46" From Center of Right to Left Clamp)



Straight Drum Rack Expansion Bar
w/ Support Leg
DR511E

RACK RAIL	Pearl 40mm Square Anodized Aluminium
SUPPORT LEG/FOOT	34"x2.5" Round Chrome w/ P38475TA Rotating Foot
USABLE RAIL AREA	36" (38" From Center of Right to Left Clamp)



Three-Sided
Drum Rack, Straight
(w/ PCX100X4 & PCL100X2)
DR513

RACK RAILS	Pearl 40mm Square Anodized Aluminium
SUPPORT LEGS/FEET	38"x2.5" Round Chrome w/ P38475TA Rotating Foot
INCLUDED RAIL CLAMPS	4 PCX100
INCLUDED PIPE CLAMPS	2 PCL100
USABLE RAIL AREA	36" (38" from Center of Right to Left Clamp)



Three-Sided
Drum Rack, Curved
(w/ PCX100X4 & PCL100X2)
DR513C

RACK RAILS	Pearl 40mm Square Anodized Aluminium
SUPPORT LEGS/FEET	38"x2.5" Round Chrome w/ P38475TA Rotating Foot
INCLUDED RAIL CLAMPS	4 PCX100
INCLUDED PIPE CLAMPS	2 PCL100
USABLE RAIL AREA	36" (38" from Center of Right to Left Clamp)



Drum Rack Moveable
Support T-Leg
DR110T

SUPPORT LEG/FOOT	34"x2.5" Round Chrome w/ P38475TA Rotating Foot
-------------------------	---



MASTERWORKS CUSTOM KIT
in Satin White Lacquer with Piano Black Stripes, Black Chrome Hardware



DMP927SP/C #229 WHITE SATIN PEARL
with 20" Gong Drum on two ICON straight racks



REFERENCE PURE #102 NATURAL MAPLE
To find out about this and other ICON RACK RECIPES, go to www.pearltrackrecipes.com

RACK ACCESSORIES

AN INDUSTRY ICON - THE PROFESSIONAL'S CHOICE

ICON RACK RECIPES

Check out Pearl's ICON Rack Recipe videos at www.pearlrackrecipes.com for step-by-step instructions on how to get the most from existing and available Pearl Rack parts.

MOUNTING CLAMPS

Developed for the slip resistant ICON square rack rail and round support pipe. Each dramatically increases the level of setup flexibility and function variety.



Expandable Pipe Clamp
Fits All Icon Rack Leg Posts
PCL100

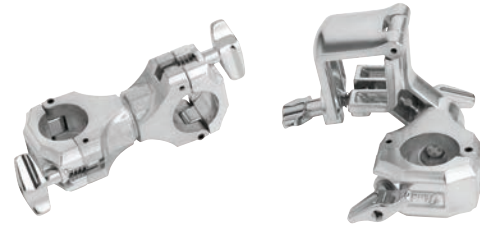

Dual Pipe Clamp
PCR100

Pipe To Rail Clamp
PCR200



Pipe To Rail Clamp
PCR200L



Rotating Pipe Accessory Clamp
PCR50X



Pipe Accessory Clamp
PCR50L

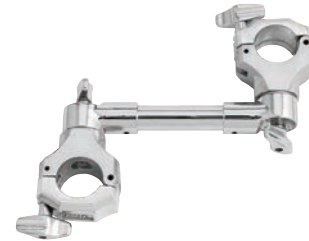

Rotating Dual Pipe Clamp
PCR50R



Curved Rack Rail
Short w/ Clamp
AL86AC



Curved Rack Rail
Medium w/ End Caps
AL103A



Icon Support Foot
w/ TLJ200 T-Clamp
P38475TA



Rail Accessory Clamp
Clamp System
w/ Adjustable Jaw
PCX100



Rotating Rail Accessory Clamp
Tilting Clamp System
w/ Adjustable Jaw
PCX200



Extended Rotating
Rail Accessory Clamp
PCX300



Pipe Clamp
Fits 7/8" tubes, for DR80
PC8



Icon
6" Mini-Expansion Bar
RJ50



Pipe Joint
RJ100



2 Clamps
Fits 5/8" to 1-1/8"
ADP20*



2 Revolving Clamps
Fits 1/2" to 1-1/8"
AX25*



2 Revolving Clamps
Fits 1/2" to 1-1/8"
AX25L*



In-Line & Revolving Clamps
Fits 5/8" to 1-1/8" & 1/2" to 1-1/4"
AX28*



3 Adjustable Clamps
Fits 3/8" to 1-1/4"
ADP30*

TOM STANDS / ARMS

POSITIONING POSSIBILITIES NEVER BEFORE ATTAINABLE



GYROLOCK



UNI-LOCK



GEAR TILTER

Our T/TC1030 Series features our GyroLock tilter for an infinite 360 degree range of movement. The T/TC930 Series use our Uni-Lock tilter for 180 degrees of motion. Our TH88 and TH70 Tom Arms Series use our dependable gear tilter.



T1030

T930

TC1030B

TC930



CHB75CA

CHB75LB

CH1030B

CH930

CH830

Mic Holder
MH830



TH1030

TH1030S

TH1030I

TH900S

TH900I

TH88S

TH88I

TH70S

TH70I



CH1030BS

CH930S

CH830S



Boomerang Curved Boom
Arm with Clamp and Tilter
CHC200

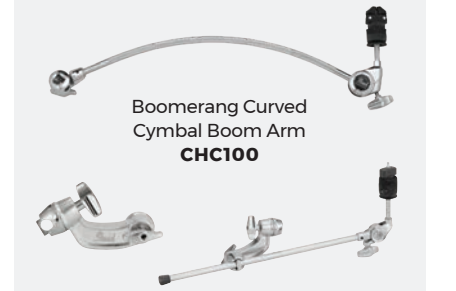

Boomerang Curved
Cymbal Boom Arm
CHC100

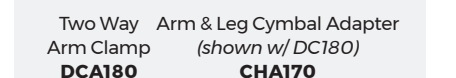

Two Way Arm & Leg Cymbal Adapter
Arm Clamp (shown w/ DC180)
DCA180



Boom Arm
Cymbal Holder
CH70

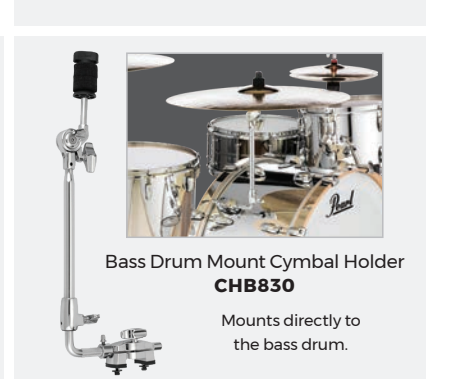

Bass Drum Mount Cymbal Holder
CHB830

Mounts directly to
the bass drum.



UX80S UX80

Features rotating infinitely adjustable clamps for multiple uses.

13" Tube Height
Extender
TX100

Accepts 7/8" dia. tubes. Ideal for extending snare stand height.

Tube Extender
for 1" Pipe
TX125

Accepts 1" dia. tubes. Ideal for extending travel conga stands.



Chrome Multi Bass Drum Legs
PMBDL3/C

Multi-Bass Drum Legs allow any bass drum to be played horizontally. Height and tilt adjustable.

PEARL PERCUSSION ARTISTS



AARON DRAPER John Mayer / Eminem / Adele
ALAIN PEREZ Alain Perez
ANDY FARAG Umphreys Mc Gee
ARCHIE PENNA Shakira
BOBBY ALLENDE Tito Nieves
BRETT BAKER Rihanna / Jay-Z



CAMILO QUINONES El Dusty
CARLITO SOTO Willie Colon
CARLITOS PADRON Rumberos Del Callejon
CESAR ESPINOZA Orchestra Tobaco Y Ron
COLIN DOUGLAS Aerosmith
CHRISTIAN PEPIN Independent



DIMAS SANCHEZ Fusion Beat / Trilogy Latin Jazz
DOMINIQUE THOMAS John Legend / Jill Scott
EMRAH KOTAN Independent
ETTIENNE FUENTES Independent
HORACIO HERNANDEZ Independent
JESSIE CARABALLO Marc Anthony



JESUS DIAZ Independent
JOSE ROSA Independent
LALO DAVILA MTSU
MARC QUINONES The Doobie Brothers
MARCO "ITO" ARGUINZONI Independent
MARVIN DIZ Independent



OG Slightly Stoopid
OMAR LEDEZMA Independent
PAPO PEPIN N.Y. Conga Legend
RAFA PEREIRA Janelle Monae
RAVI JAKHOTIA Ravi Drum
ROBERTO VIZCAINO JR. Orquesta Akokan



ROLANDO MORALES MATOS The Lion King / Curtis Institute
SAMMY FIGUEROA Master Percussionist
SAMMY GARCIA Independent
TRILOK GURTU Independent
VALERIE DEE NARANJO Saturday Night Live Band
ZIG WALJER Hands-On With Zig

SIGNATURE CONGAS & BONGOS

THE PROS PLAY PEARL!

BOBBY ALLENDE FIBERGLASS CONGAS AND BONGOS



#617 Confetti
Signature Fiberglass Congas and Bongos

CONGAS
PCF110DXBA617 11" QUINTO
PCF117DXBA617 11.75" CONGA
PCF125DXBA617 12.5" TUMBA
BONGOS
PBF300DXBA617 7" & 8.5"

Bobby Allende is a mainstay in the New York Latin Music Scene and he demands the best from his drums, that's why he plays Pearl. Bobby demands the best, so he designed his Signature Congas and Bongos to exceed all existing standards, right down to the smallest details. For example, the seams are invisible thus giving his Fiberglass congas the look of wood. The beauty of these drums is more than skin deep, the thick fiberglass shells produce a rich tone and projection sure to get you noticed. The congas stand 28" tall to fit the traditional seated player and the wider base adds even more projection and stability. The superior rim design of the polished Contour Crowns on both the congas and bongos adds significant comfort for the player while complimenting the Remo heads. The drums feature a new super high gloss lacquer in #617 Confetti, personally designed by Bobby.



SHELL	Seamless Fiberglass
HEADS	Remo Fiberskyn3
RIMS	Low-Rider Contour Crown
HARDWARE	Brushed Steel
FINISH	#617 Confetti
BONGOS	PBF300DXBA
OPTIONAL BAGS	PSCT10CG 11" Quinto Conga Bag PSCT17CG 11.75" Conga Bag PSC125CG 12.5" Tumba Conga Bag

JESUS DIAZ SIGNATURE OAK CONGAS AND BONGOS



#580 Brushed Platinum
Natural Buffalo Skin Heads

CONGAS
PCW110DXPJ580 11" QUINTO
PCW117DXPJ580 11.75" CONGA
PCW125DXPJ580 12.5" TUMBA
BONGOS
PBW300DXJ580 7" & 8.5"

Cuban born Jesus Diaz is one of the most in demand percussionists and vocalists on the scene today. His active schedule provided the feature set for his signature series of congas and bongos. Designed for the seated player the Thai Oak drums measure 30" tall and from the Quinto to Tumba feature added girth to the belly of the drum. Seated conga players typically have to tilt the drum to achieve the desired projection, but the Jesus Diaz drums feature a 4" port on the front of the drum that is strategically positioned to deliver the maximum base frequency while the drum remains flat on the floor.



The drums also feature a newly designed Quick Release lug that is slotted to allow removal of the tension rod without fully removing the nut. A new ergonomically friendly design reduces the impact to your hands while an internal ring centers the head for accurate placement.

SHELL	Thai Oak
HEADS	Buffalo Skin
RIMS	Low-Rider Contour Crown
HARDWARE	Quick Release Lugs Brushed Steel Finish
FINISH	#580 Brushed Platinum
BONGOS	PBW300DXJD
OPTIONAL BAGS	PSCT10CG 11" Quinto Conga Bag PSC117CG 11.75" Conga Bag PSC125CG 12.5" Tumba Conga Bag

CONGAS & BONGOS

TOOLS OF THE TRADE



ELITE SERIES



ELITE WOOD-FIBER CONGAS
PWFC110DX648 - 11" QUINTO
PWFC117DX648 - 11.75" CONGA
PWFC125DX648 - 12.5" TUMBA

SHELL	Blended, Thai Oak over Fiberglass
HEADS	Natural Cow Skin
RIMS	Contour Crown
HARDWARE	Brushed Steel
FINISH	#648 Maduro Brown

ELITE WOOD-FIBER BONGOS
PWFB100DX648 - 7" & 8.5"



ELITE OAK CONGAS
PCW110DX504 - 11" QUINTO
PCW117DX504 - 11.75" CONGA
PCW125DX504 - 12.5" TUMBA

SHELL	100% Thai Oak
HEADS	Premium Natural Cow Skin
RIMS	Contour Crown
HARDWARE	Chrome
FINISH	#504 Mocha Burst

ELITE OAK BONGOS
PBW300DX504 - 7" & 9"



ELITE OAK CONGAS
PCW110DX510 - 11" QUINTO
PCW117DX510 - 11.75" CONGA
PCW125DX510 - 12.5" TUMBA

SHELL	100% Thai Oak
HEADS	Premium Natural Cow Skin
RIMS	Contour Crown
HARDWARE	Brushed Steel
FINISH	#510 Caramel Brown

ELITE OAK BONGOS
PBW300DX510 - 7" & 9"



ELITE OAK CONGAS
PCW110DX506 - 11" QUINTO
PCW117DX506 - 11.75" CONGA
PCW125DX506 - 12.5" TUMBA

SHELL	100% Thai Oak
HEADS	Premium Natural Cow Skin
RIMS	Contour Crown
HARDWARE	Chrome
FINISH	#506 Merlot Burst

ELITE OAK BONGOS
PBW300DX506 - 7" & 9"



ELITE FIBERGLASS CONGAS
PCF110DXA - 11" QUINTO
PCF117DXA - 11.75" CONGA
PCF125DXA - 12.5" TUMBA

SHELL	Fiberglass
HEADS	Premium Natural Cow Hide
RIMS	Contour Crown
HARDWARE	Brushed Steel
FINISH	#641 Blue Sparkle Burst

ELITE FIBERGLASS BONGOS
PBF300DXA - 7" & 9"



ELITE OAK CONGAS
PCW110DXG - 11" QUINTO
PCW117DXG - 11.75" CONGA
PCW125DXG - 12.5" TUMBA

SHELL	100% Thai Oak
HEADS	Premium Natural Cow Skin
RIMS	Contour Crown
HARDWARE	Gold
FINISH	#535 Satin Black

ELITE OAK BONGOS
PBW300DXG - 7" & 9"

Also available in #532
Cherry Eucalyptus

HAVANA SERIES

The wide belly shape of these high end, fiberglass drums produce deeper low tones and greater volume.



SHELL	Fiberglass
HEADS	Natural Cow Skin
RIMS	Contour Crown
HARDWARE	Chrome
FINISH	#644 Liquid Gold

HAVANA CONGAS
PCF110HV - 11" QUINTO

PCF117HV - 11.75" CONGA

PCF125HV - 12.5" TUMBA



SHELL	Fiberglass
HEADS	Natural Cow Skin
RIMS	Contour Crown
HARDWARE	Chrome
FINISH	#187 Silver White Swirl



SHELL	Fiberglass
HEADS	Natural Cow Skin
RIMS	Contour Crown
HARDWARE	Gold
FINISH	#651 Red Tiger Stripe

HAVANA BONGOS
PBF300HV - 7" & 8.5"

PRIMERO PRO

PCF302DX626 #626 Gold Marble



Pearl's ever-popular Primero Pro congas and bongos are designed with professional features at an affordable price. Our expanded range of sizes offers 10" & 11" and 11.75" & 12.5" sets in both Thai Oak and Fiberglass with matching bongos.

PRIMERO PRO FIBERGLASS



11.75" & 12.5" Conga Set #628 Blue Marble
 Shown with matching bongos
PFC302DX628



12" Conga #621 Wine Red Marble
PFC120DX621

10" & 11" Conga Set #621 Wine Red Marble
PFC202DX621



7" & 8.5" Bongos #523 Carbon Vapor
PWB100DX523

11.75" & 12.5" Congas #523 Carbon Vapor
PWC302DX523

PRIMERO PRO FIBERGLASS
PFC302DX (11.75" & 12.5" Conga Set)
PFC202DX (10" & 11" Conga set)

SHELL	Fiberglass
HEADS	Buffalo Skin
RIMS	Contour Crown
HARDWARE	Brushed Steel
FINISH	#621 Wine Red Marble #626 Gold Marble #628 Blue Marble

Offer added durability of fiberglass and are louder drums with a crisper sound than wood.

PRIMERO PRO OAK
PWC302DX (11.75" & 12.5" Conga Set)
PWC202DX (10" & 11" Conga set)

SHELL	Thai Oak
HEADS	Buffalo Skin
RIMS	Contour Crown
HARDWARE	Brushed Steel
FINISH	#511 Natural #521 Midnight Fade #523 Carbon Vapor

Primero Pro wood congas are made with Thai Oak and produce a warm, rich tone.

PRIMERO



10" & 11" Conga Set w/ PC300 Stand
PFC203602

Primero Series congas and bongos are available with fiberglass shells and in packages that include a double stand (PC300W) or without stands.



10" & 11" Conga Set
PFC202602

SHELL	Fiberglass
HEADS	Buffalo Skin
RIMS	Contour Crown
HARDWARE	Black Powder Coat
FINISH	#602 Bistre Black

FIELD PERCUSSION



Weather resistant fiberglass body that delivers a thunderous low-end tone. Remo Nuskyn heads.

10" & 11" Congas
 #649 Textured Black
PFC202EDU649

CONGA RESO-PLATE



Designed for the seated conga player, Pearl's Reso-Plate will give you that hard surface desired for maximum resonance. Configured with a cutout handle, the plates can also easily be placed on top of your drums for extra protection when packed in your conga case.

Conga Reso-Plates
PRP140

TRAVEL

CONGAS,
BONGOS,
& TIMBALES

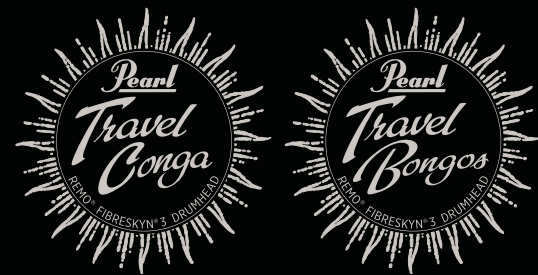

Where can you take the Pearl Travel Congas and Bongos? The answer is anywhere you can take traditional drums but without any of the hassle. The Travel Congas feature a 3.5" deep wood shell with stave construction and Remo Symmetry heads. Available in three sizes: 11" x 3.5", 11.75" x 3.5" and 12.5" x 3.5" each with five precision Allen bolts. The 7" and 8.5" Travel Bongos feature 3.5" Thai Oak shells with Remo Fiberskyn heads and three point tuning. The Travel Congas and Bongos include a foam-handle tuning wrench.



11.75" Travel Conga
#510 Caramel Brown
PTC1175N

12.5" Travel Conga
#510 Caramel Brown
PTC125N

11" Travel Conga
#510 Caramel Brown
PTC1100N



Travel Conga Bag
PSC1175C

Travel Bongos Bag
PSC785TB

The optional Travel Conga Stand works with all three size drums and features a tension lever mounting system that locks the drum into place. The wide based, double braced legs provide a solid foundation for your drum and prevents the stand from moving during performance.



Travel Bongos
#510 Caramel Brown
PTB785



Travel Conga Stand
w/ Carrying Bag
PC800TC

Travel Bongos Stand
PC800TB
PC800TBS (Short)



Travel Timbales 14" & 15"
with Stand*
PTTM1415



The Pearl Travel Timbales feature 14" and 15" steel shells that are professional size in diameter but only 4" deep.



The drums are connected by a hinge that marries them to the Quick Release stand. The custom hinge allows the drums to be folded together into the size of one standard depth timbale for easy storage and transportation.



The Travel Timbales come with and a single braced stand that includes an 11.25" adjustable accessory post with 6 positions that allow cowbells and blocks to be placed the perfect distance from the player.

The steel shells feature a black lacquer finish and USA Remo clear Ambassadors heads for a truly professional sounding instrument. A soft carrying case for the stand is also included (sold separately).

*Bag sold separately

TIMBALES

BUILD THE RIGHT RIG FOR THE GIG!



MARC QUIÑONES
Doobie Brothers

MARC QUIÑONES
SIGNATURE TIMBALES



Primero
13"x7" Steel Timbale
w/ PPS36 Mount
PTE1336



Flat Timbale w/ I.S.S.
13"x3" Steel
PTE3131



Flat Timbale w/ I.S.S.
13"x3" Brass
PTB3131



BANDA SERIES



Banda Timbales
15"x10" / 16"x10" Steel
w/ Tilting Stand
PBTM1516/C



Banda Tambora
24"x18" Bass w/ Cymbal
Mount, Stand & Mallet
PBTB2418/C33



Tilting Timbale
Stand (Short) Height
Range 26.5" to 36.5"
PT900WS



Primero Timbales
13"x6.5" / 14"x6.5" Steel
w/ PT900 Tilting Stand
(Stands & Cowbell Included)
PTS5134



Primero Pro Timbales
14"x7" / 15"x7" Steel
w/ PT900 Tilting Stand
(Sticks Included.
Cowbell Not Included.)
PTE1415DX



Marc Quiñones
Signature Timbales
14"x7" / 15"x7" Steel
w/ PT900 Tilting Stand
and PBL30 Clave Block
(Cowbell Not Included)
ETE1415MQ

COWBELLS



HORACIO HERNANDEZ
Independent

HORACIO HERNANDEZ
SIGNATURE COWBELLS

Pearl and Grammy Award winning artist Horacio Hernandez have developed the ultimate family of cowbells. The HH4XH bell features a quick release system that allows the bell to lift easily off of its mount for hand held playing.



Marybell
HH5

Hand-Held Campana
Quick Release
HH4XH

Isabell
Mambo Bell
HH4

Chabella
HH3

Clabell
HH2

Bella
HH1

AGOGO & TRIBELLS



Tri-Bells
PTB30

Hand-Held
Agogo
ECB22

Mounted
Agogo
ECB23

NEW YORKER BELLS



Cha-Cha (High)
BCM3NY

Cha-Cha (Low)
BCM5NY

Mambo
BCM7NY

Marc Quiñones
Sig. Timbale Bell
BCM8NYQ

Mounted
Campana Bell
BCM10

Hand-Held
Campana Bell
BCH10

AGOGO & TRIBELLS



Tri Agogo
PTA30

Pro
Cowbell Beater
PDC60

Dual
Cowbell Beater
PDC10

PRIMERO COWBELLS



10" Bell w/ PPS30
PCB1030

6" Bell
PCB6

4" Bell
PCB4

8" Guiro Cowbell
PCB10GR

10" Millennium Chrome Bell
PCB10MCR

10" Anarchy Bell
PCB20

DJEMBES

ANCIENT INSTRUMENTS FOR THE MODERN PERCUSSIONIST

DJEMBES Djembes are a traditional African instrument that offer a wide variety of sounds and are perfect for drum circles. The Professional Elite Series is available in Oak (12.5" diameter) and Fiberglass (12.5" and 14" diameter). All feature our Contour Crowns for comfortable playing and authentic Goat skin heads for deep lows and crisp highs.

#696 PURPLE HAZE
Top Tuned Djembes



8" x 16" PBJV8696	10" x 19.5" PBJV10696	12" x 24" PBJV12696	14" x 25.5" PBJV14696	14" x 25.5" PBJV14697	12" x 24" PBJV12697	10" x 19.5" PBJV10697	8" x 16" PBJV8697
----------------------	--------------------------	------------------------	--------------------------	--------------------------	------------------------	--------------------------	----------------------

#697 TRIBAL FIRE
Top Tuned Djembes

#698 ZEBRA GRASS
Rope Tuned Djembes



7" x 12.5" PBJVR7698	10" x 19.5" PBJVR10698	12" x 24" PBJVR12698	14" x 25.5" PBJVR14698	14" x 25.5" PBJVR14699	12" x 24" PBJVR12699	10" x 19.5" PBJVR10699	7" x 12.5" PBJVR7699
-------------------------	---------------------------	-------------------------	---------------------------	---------------------------	-------------------------	---------------------------	-------------------------

#699 MOLTEN SCARLET
Rope Tuned Djembes



Field Percussion Djembe
14" (Fiberglass)
#649 Textured Black
PJF350FP649

Elite Oak Djembe
12.5"
#511 Natural
PJV340

Elite Fiberglass Djembe
#602 Bistre Black
PJF350 14"
PJF320 12.5"

Fiberglass
Fun Drum
PFD300



12" Hand Carved
Mahogany Djembe
#695 Malinke Village
PBJWR12695



Djembe Stand • Fits 8" to 14" Pearl
Rope Tuned And Top Tuned Djembes
PBJSTD



Djem-Bass
PJBS350

DJEM-BASS The PJBS350 Djem-Bass Attachment allows you to convert any Pearl 14" djembe into a sub-sonic bass drum. To reduce the attack and add greater "lows," we have included a cloth cap that stretches around the head. For smoother low-end with a slightly reduced attack, slip the included neoprene disc inside, allowing for two distinct sound options. A pedal (not included) attaches via an I.S.S. clamp to the djembe's stand mounting plate. Includes two legs with mounting hardware, pedal bracket, head cover and neoprene muffler.

FOLKLORIC

TRADITIONAL LOOK, MODERN INNOVATION



Tumbador 12.5" PCW125FC	Qunito 11" PCW110FC	Segundo 11.75" PCW117FC	Folkloric Elite Bongos 7" & 8.5" PBW300FC
----------------------------	------------------------	----------------------------	--

#526 CRIMSON SUNRISE

Itotele
PBA60

Oconcolo Iya
PBA50 PBA70

Bamboo Clave
PCL10FCB

Wood Clave
PCL20FCW



FOLKLORIC ELITE CONGAS Pearl's Folkloric line of congas feature a traditional look with modern innovation that only Pearl can deliver. Each 28" tall Oak drum is designed for the "seated" player, but includes stand mounts for players who prefer to stand. Thicker South American-style natural skin heads make the drums warm-sounding, but a fiberglass gel coating on the interior seals the shell and add the projection and volume desired by today's players. Four Polished Steel Reinforcing Bands are inset on the shell for a smooth touch, and the traditional hoops complete these stunning Cuban instruments.

BATAS Pearl Percussion Bata drums are available in Crimson Sunrise, the same beautiful finish featured on our Folkloric Elite congas and bongos. Additionally, the hardware is finished in Polished Steel and matches the hardware on our other tunable hand drums. These sacred ceremonial instruments have a thicker Enu (large) head for a deep, rich tone.



Uno PSK50FC	Segundo PSK60FC	Caja PSK70FC	10" Segundo PBSK70	Shekere PSK10	Fiberglass Shekere PPS45	Shekere Holder PCA14FC	Achere PAC10FC	Guataca PGT10FC
----------------	--------------------	-----------------	-----------------------	------------------	-----------------------------	---------------------------	-------------------	--------------------



Timbao PBTB140	Tan Tan PBTA1420	Surdo 20" PBS2018	Surdo 18" (Shown with optional PBS30BD) PBS1822	Surdo 22" PBS2222
-------------------	---------------------	----------------------	--	----------------------

Legs & BD Adapter
Kit For Surdo
PBS30BD

Tamborim Stick
PBT70S

Surdo Mallet
PBSM20

Rocar
PBR80



BRAZILIAN

BRAZILIAN PERCUSSION Pearl's line of Brazilian Percussion brings modern refinements and Pearl quality to the traditional Samba musician. Our Repinique features lightweight yet sturdy steel shells with etched heads, shoulder straps and low rims for incredible playing comfort. The lightweight wood shell Surdos allow for hours of comfortable play when worn over the shoulder with the provided strap. Available in 18"x22", 20"x18" and 22"x22" sizes (diameter x depth), Pearl's popular Surdos continue to be the industry standard. The Timbao is made from lightweight fiberglass, and is capable of the extremely high tension utilized in tradition Brazilian ensembles. The Rocar is equipped with brass and steel platinellas, and can be played as a single shaker, or separated for two-handed sonic options.



Caixa 12" PBCX1204	Caixa 12" PBCX1265	Cuica PBC80SS	Repinique 10" w/ Strap PBR10S	Repinique 12" w/ Strap PBR12S
-----------------------	-----------------------	------------------	----------------------------------	----------------------------------



Pandeiro 10" (5 Sets Platinellas & Goatskin Head) w/ Bag PBP510	Pandeiro 12" (6 Sets Platinellas & Plastic Head) w/ Bag PBP612	Pandanza w/ Agogo Bell PDZ510	Tamborim w/ Quick Draw Mount PBT60C
--	---	----------------------------------	--

CAJONS

GET IN THE CAJON ZONE!

Primero Cajons (all on pg. 88)

BODY	Medium-density Fiberboard
SNARES	Fixed, two sets
BASS PORT	Patented, built in, rear facing

The body of these Primero cajons is constructed using MDF, Medium-density Fiberboard which creates a solid and durable sound chamber. Four of these models feature Meranti faceplates. Meranti is a wood known for its relative hardness and straight grain making it ideal for cajons. A built in bass port magnifies the massive low-end tone of the cajon while two sets of fixed snare wires provide a bright, crisp snare response. Each of these Primero cajons feature a look as distinctive as the percussionist who play them.



19.25" T x 11.75" W x 11.75" D

Primero Abstract Red Cajon PBC120B
FACEPLATE Meranti Replacement Model # FP123B
FINISH Abstract Red body with black faceplate



Its unique finish is an abstract red print on a cloth sarong that is applied to the body of the cajon and is accentuated by the ebony front.



19.25" T x 11.75" W x 11.75" D

Primero Figured Cherry Cajon PBC121B
FACEPLATE Figured Cherry Replacement Model # FP123B
FINISH Natural Figured Cherry with gloss black body

Features a stunning figured Cherry faceplate. Because of its hardness, tonally cherry is a close match to maple and when used on a cajon provides more bottom-end.



18.75" T x 12.5" W x 12.5" D

Jingle Cajon PCJ629616
FACEPLATE Asiatic hardwood
BODY Fiberglass
SNARES Fixed, three sets
BASS PORT Rear facing
FINISH #616 Artisan Wood Grain

Simply twist open the Brazilian Platinella-style jingles and a new world of sonic options open up, as you sound like two percussionists blending simultaneously.



19.25" T x 11.75" W x 11.75" D

Primero Music Town Cajon PBC122B
FACEPLATE Meranti Replacement Model # FP123B
FINISH Crate style body with graphic faceplate

The Music Town USA cajon is designed to resemble a wooden crate and the faceplate features the names of some of America's iconic music cities.

Primero Tree of Life Cajon PBC123BTR
FACEPLATE Meranti Replacement Model # FP123B
FINISH Hand painted and silkscreen Tree of Life

The Tree of Life cajon features a hand painted and silkscreen design that wraps around three sides and depicts the Tree of Life.



19.25" T x 11.75" W x 11.75" D

Primero Raven Cajon PBC121B
FACEPLATE Meranti Replacement Model # FP123B
FINISH Hand painted and silkscreen black raven

The Raven cajon's finish is a hand painted and silkscreen design that wraps around 3 sides featuring a stylized black raven.



18.75" T x 12.5" W x 12.5" D

Boom Box Cajon PCJ633BB635
FACEPLATE Asiatic hardwood
BODY Fiberglass
SNARES Fixed, three sets
BASS PORT Built in, rear facing
FINISH #635 Artisan Zebra Wood

The Boom Box Cajon creates never-before-heard low-end frequencies from a Fiberglass cajon! Features a fixed snare system and a built-in bass port for subsonic frequencies you have to hear to believe!

Pearl

CAJON ACCESSORIES

Enhance your performance by adding new, dynamic sounds.

Cajon Holster Nylon w/ Velcro Straps CAJH100

Wood Block w/ 3M Dual-Lock Tape & Mounting Bracket (PPS37 Not Included) PBCW100

Jingle Cup Two Pack Suction Cups attach to the cajon face, acoustic guitars, or other drums. PJCP1/6

Clave Block w/ 3M Dual-Lock Tape & Mounting Bracket (PPS37 Not Included). Play handheld or stand mounted. PBC100

Seat Cushion w/ Thick Foam. Adds comfort for long sessions. PSCBC

3 Way Cajon Riser First Lift = 21", Second Lift = 23", Third Lift = Angled Option PBCR1535



AWAKENING SERIES TONGUE DRUMS

Pearl proudly introduces the Awakening Series of 6 Tongue Drums: Three 8 note and three 9 note drums tuned to pentatonic scales.

TONGUE DRUMS

Tongue drums derive their name from the tongue shaped areas where you strike the drum. The results are a cosmic blend of tones that are as much fun to hear as play.

8 Note G Major #687 Blue Burst PMTD8CMF687

8 Note A Ake Bono #688 Brown Burst PMTD8AKBF688

8 Note A Minor #689 Green Burst PMTD8AMF689

9 Note C Lydian #690 Orange Burst PMTD9LYDF690

9 Note C Major #691 Crimson Burst PMTD9CPTF691

9 Note C Ake Bono #692 Purple Burst PMTD9AKBF692

Each drum features a 10" hardened steel shell with precise laser cut tongues for accurate and consistent tuning. Pearl Tongue drums can be played with your fingers or with a set of mallets included with each drum.

Rubber mallets included

Tongue Drum Bag PTDB10B

AWAKENING SERIES

RAINSTICKS AND NUT SHAKERS

CONCERT PERCUSSION

ENGINEERED FOR THE PROFESSIONAL PERCUSSIONIST

RAINSTICKS

BAMBOO RAINSTICKS WITH BURNED FINISH #694 RHYTHM WATER



- 60" Bamboo Rainstick **PBRB60694**
- 48" Bamboo Rainstick **PBRB48694**
- 40" Bamboo Rainstick **PBRB40694**
- 32" Bamboo Rainstick **PBRB32694**
- 24" Bamboo Rainstick **PBRB24694**
- 16" Bamboo Rainstick **PBRB16694**

Pearl's natural Bamboo Rainsticks are 2.5" in diameter and feature an internal spiral maze of tines that a cascade of lava pebbles flow over to create the soothing sound of falling rain.

Pearl has expanded its line of shakers to include six Bamboo rainsticks ranging in size from 16" to 60" and available in two unique finishes.

- 16" Bamboo Rainstick **PBRSP16693**
- 24" Bamboo Rainstick **PBRSP24693**
- 32" Bamboo Rainstick **PBRSP32693**
- 40" Bamboo Rainstick **PBRSP40693**
- 48" Bamboo Rainstick **PBRSP48693**
- 60" Bamboo Rainstick **PBRSP60693**

BAMBOO RAINSTICKS WITH PAINTED FINISH #693 HIDDEN SPIRIT

NUT SHAKERS

The Awakening Series has been expanded to include a series of natural nut shakers that provide earthy tones that complement the series. Kenari, Bendo, and Pangli nuts range in size from small, medium, and large and each size possesses unique sound properties. From the recording studio to the yoga studio Pearl's Awakening Series has an instrument and sound that will inspire you.

NOTE: Items pictured are not to scale



Pangi Nut Shaker w/ Rope Handle **PBGRH14**



Pangi Nut Shaker w/ Bamboo Handle **PBGBH12**



Bendo Nut Shaker w/ Rope Handle **PBBDSCRH**



Kenari Nut Bracelet Shaker **PBGLKEN**



26 Kenari Nut Wind Chime "Clamp not included" **PBKENCH01**



Kenari Nut Shaker 7" **PBCHKENL**

Pearl is proud to offer Concert Percussion instruments that are attractively priced for school ensembles, yet engineered with the professional percussionist in mind. The symphonic tambourine is a perfect example. Its 17 pairs of specially aged, stamped brass jingles provide a dry, yet bright tone that brings added color to any musical situation. Its 10" headed

wood frame allows the player to effortlessly perform all tambourine techniques, and the tambourine's plush carrying case is included. The rattler is another vital component to any concert percussionists' equipment, and Pearl's is built with an extended handle for a comfortable grip and ease of playing. Holders for the rattler and castanets are also available.



16" Ocean Drum **PSFM16**



Castanets (Long Handle) **PCN20** Castanets **PCN20S** Castanets Holder **PCN20H** Slap Stick **PSS100** Elite Concert Wood Blocks (High) **PCWB100A** (Medium) **PCWB200A** (Low) **PCWB300A** Mounting Bracket incl.



Stix-Free Triangle Holder w/ 8" Triangle **PPS12T** Triangle 10" **PET100** 8" **PET80** 6" **PET60** Triangle Beater **PETB30** Triangle Clip **PTC10** Trio Triangle Holder **PTC300** Storage Pouch incl. Rattler Mounting Clamp **PRT10C** Temple Blocks **PCWTB05** Rattler **PRT10**



Elite Concert Tambourine **PETM20** Symphonic Tambourine **PETM1017** 14" Frame Drum **PFR14C** Frame Drums Set of 6 - Sizes: 8", 10", 12", 14", 16", 18" **PFR0818C**

ORCHESTRAL TAMBOURINES

The Pearl Orchestral Series Professional Tambourines provide performers a new voice and sound for any performing situation. These 5 instruments feature uniquely sourced and hand-hammered jingles combinations of German Silver, Phosphor Bronze, Beryllium Copper, and Yellow Brass that give a full spectrum of color and projection options to players. The 10" shell is a well-balanced and lightweight 2-ply Mahogany design with contoured hand-hold areas for comfortable performance and warm tone. The natural finish goatskin head provides a full responsive sound and traditional look without sacrificing durability. Includes bag.



Mix Copper And Brass **PETM1018CR** Mix Copper and Bronze **PETM1018CB** Mix German Silver and Copper **PETM1018GC** Beryllium Copper **PETM1018CP** German Silver **PETM1018GS**

HAND PERCUSSION

A WORLD OF HAND PERCUSSION



Blocks, bells, shakers and more. choose from a complete selection of hand percussion instruments to add color and impact to your music.



Natural Courd Guiro
PNG20

Two scraping surfaces: thin grooves on one side for a lighter sound and thicker cut channels on the other side for a beefier sound. The interior is coated with fiberglass gel coat to add projection and volume.



Metal Guiro
PMG20

Perfect for Merengue rhythms, or just a different metallic sound texture, Pearl's Metal Guiro will become an essential ingredient in your "toy" bag. Scraper included.



Fiberglass Guiro
PFG20

Pearl's Fiber Guiro is light-weight and provides optimal projection due to its fiberglass construction. With the included striker and two different playing surfaces you have a world of sonic possibilities in your hand.



Guiro Holder
PCH20

This innovative design will hold virtually any size guiro secure for one handed playing. Easily mountable off the lug of your conga or any 3/8" post, Pearl's Guiro Holder uses a track system to lock the guiro in place. Included is a 3/8" "Z" rod so you can also mount your favorite accessory as well.



Beaded Maracas
PFM20

The Beaded Maracas feature Shekere-style beads which offer an excellent sound with greater control, and foam handles for enhanced comfort.



Maracabasa
PFM50

The Maracabasa is two great instruments in one, combining the functionality of a maraca and a cabasa in one handheld instrument. Featuring a ribbed fiberglass body wrapped in shekere-style beads.



Basket Ganza 9" X 4"
PGA20

The Pearl basket ganza is a 9"x4" woven tube containing wooden sticks instead of conventional shot. The wood sticks produce an airy percussion sound.



Shakelets
PWR40

This innovative percussion item feature exclusive "Ganzinellas", Brazilian-style platinellas combined with ganza shakers that are worn on the wrists to produce a shaker sound when playing.



Spirit Chimes w/
Holder and Mallet
PSC30BR

Spirit Chimes have many applications in school bands, percussion ensembles and music programs. They are also perfect for meditation and yoga studios.



36 Anodized Aluminum Chimes w/ Case, Holder, And Striker
PWCH3620A

Satin black frame with polished bars
Self-dampening parallel swinging chimes



32 Gold Anodized Aluminum Chimes w/ Case, Holder, and Striker
PWCH3220G

32 Gold anodized aluminum chimes
Self-dampening parallel swinging chimes



32 Bar Aluminum Windchimes w/ Case, Holder, and Striker
PWCH3220A

32 Anodized Aluminum Chimes
Self-dampening parallel swinging chimes



Foldable 36 Anodized Aluminum Chimes
PWCHF3620AF

Individually strung, goes from 19.25" to 9.75"
Self-dampening parallel swinging chimes



9" Primero Rock Tambourine w/ Millennium Jingles
PTM09BK

The Primero Rock Tambourine features 6 double sets of Millennium Chrome Jingles in a matte black oval frame.



Headless Wood Tambourines
PTH10B (Brass)
PTH10S (Steel)

Brass is an alloy of copper and zinc and the jingles provide a bright mid-range tone.



Tambourine w/ Brass Jingles
PTM10GH

Stainless Steel jingles produce a higher tone with extra top end and sustain.



Steel Jingle Tambourine w/ Stainless Steel Jingles
PTM10SH

Features an inverted handle that shifts the balance point of the tambourine for improved control. Six double rows of Brass jingles create a warm metallic sound.

Features an inverted handle that shifts the balance point of the tambourine for improved control. Six double rows of Steel jingles create a bright metallic sound.



Hi-Hat Jingle Ring
PJH10SH

The Hi-Hat Jingle Ring has 20 sets of Stainless Steel tambourine style jingles that will accentuate your Hi-Hat sound with every opening and closing of your cymbals.



Ultra Grip Volume Adjustable Tambourine
PTM50BHR (Brass)
PTM50SHR (Steel)

The jingle control discs can be moved to the outside to allow the jingles to ring freely. As the jingle control discs are tightened the more restricted the jingle.



Gatling Cabasa
CBS100

Brass is an alloy of copper and zinc and the jingles provide a bright mid-range tone. Steel jingles have a higher tone with extra top end and sustain.

Simply grab the precision handle and fire away to play any pattern you wish, or keep spinning it for an infinite "sizzle" that is not possible with standard Cabasas.



Beaded Maracas
PFM20

The Beaded Maracas feature Shekere-style beads which offer an excellent sound with greater control, and foam handles for enhanced comfort.



Maracabasa
PFM50

The Maracabasa is two great instruments in one, combining the functionality of a maraca and a cabasa in one handheld instrument. Featuring a ribbed fiberglass body wrapped in shekere-style beads.



Basket Ganza 9" X 4"
PGA20

The Pearl basket ganza is a 9"x4" woven tube containing wooden sticks instead of conventional shot. The wood sticks produce an airy percussion sound.



Shakelets
PWR40

This innovative percussion item feature exclusive "Ganzinellas", Brazilian-style platinellas combined with ganza shakers that are worn on the wrists to produce a shaker sound when playing.



Spirit Chimes w/
Holder and Mallet
PSC30BR

Spirit Chimes have many applications in school bands, percussion ensembles and music programs. They are also perfect for meditation and yoga studios.



Tang-Tang
PTG20

A high and low pair of unique shakers that incorporate a Caxixi-Style Plate and Wooden "Clacker."



ASH TONE BLOCKS

(High) **PAB20** (Medium) **PAB50** (Low) **PAB100**

Pearl's Ash Tone Blocks are constructed using Ashwood because it is extremely hard and durable. The Ash Tone Blocks are pitched in "thirds" and each block includes a mounting bracket that accepts a 3/8" post.



CLAVE BLOCKS

(High) **PBL10** (Medium) **PBL20** (Low) **PBL30** Anarchy Block **PBL100**

Pearl's clave blocks are injection molded so they're virtually indestructible, and the solid color will never chip, fade, or peel. Our exclusive CDV (Chamber Density Variation) Technology process allows all three clave blocks to be the same dimensions but still differ in pitch.

Produces a low piercing pitch that will cut through even the heaviest metal rhythm section.



21" Field Percussion Shaker
PGA60FP

Hexagonal body and internal chamber for a truly massive sound.



Wood Hex Ganzas
PGA30W (Short) **PGA32W** (Long)

The wood Hex Ganzas are made from Shorea wood and maintain the same strong projection as their aluminum brothers, but deliver a warmer less metallic tone.



Hex Ganzas
PGA30 (Short) **PGA32** (Long)

The Pearl aluminum Hex Ganzas give more sound control than round shakers and produce a lush shake sound due to their hexagonal shape.



Triple Shaker
PGA40

This 6" long, rectangular aluminum shaker provides three unique sounds: shake, click, and swish.



Groove Shaker
PGA50SF

Can be played as a traditional shaker or while holding a drumstick.



Egg Carton
PEC1

Three egg shakers in a clear tube that can be played separately or as a complete unit.

STANDS

PRO TOOLS FOR EVERY GIG



PERCUSSION STANDS & BRACKETS

The PC3000TW stand holds full size professional congas as securely as most stands double its weight and mass. The PC3000W is scaled down to support our lighter Primero Conga lineup. Both stands setup in seconds because there are no wingnuts needed to mount your congas. The PC2500 Ultralite Conga stand, is lightweight yet sturdy and stable. Index markings on all adjustable parts make for consistent lightning fast setups.

CONGA STANDS



Pro Conga Stand
PC3000

Quick Release Double
Conga Stand w/ Bag
PC3000TW

Ultra Lite
Conga Stand
PC2500



All-Fit
Conga Stand
PC900

Quick Release
Double Conga Stand
PC300W

Primero Twin
Conga Stand
PC200

Primero Basket Conga Stands
PC100P (10") PC110P (11")

BONGO STANDS



Pro All Fit Bongo Stand with
Spring Loaded Strap Hinge
PB3000

Bongo Stand for
Seated and Concert Players
PB3000S

All-Fit Tilting
Bongo Stand
PB900LW

Lightweight
Bongo Stand
PB700

Bongo Attachment
for PC200
PB700BHS

DJEMBE STANDS



Pro Djembe Stand
PD3000

All-Fit Djembe Stand
PC800S

CAJON STANDS



Cajon Stand
PCJ70STD

TRAP TABLES

Our popular PTT1824 Trap Table can be easily converted into a two-level folding rack without drilling or modifications by simply adding the PTR1824 Add-On Rack. The PTR1824 installs in seconds using clamps and folds flush with the table for easy pack-up. A unique clamping system allows the included (4) straight and (4) angled 3/8" knurled posts to clamp anywhere onto horizontal or vertical areas of the rack. Also included is a retractable three-legged stabilizer bar for optimum stability. The easy-to-attach PTRUNV Universal Trap Table Rack mounts on virtually any trap table and features six 3/8" rods and receptors for various percussion mounting possibilities.



(Table & Stand Sold
Separately From Rack)

Universal Trap Table Rack
PTRUNV

Trap Table Rack
PTR1824

PERCUSSION CASES

Features include: ergonomic carrying straps, rubber protective bottoms, top-mounted carrying handles, tuning wrench pouches, & heavy duty double zippers.

Fits Havana Series



Conga Bag - Quinto **PSC110CGW** Conga Bag - Conga **PSC117CGW** Conga Bag - Tumba **PSC125CGW** 12" Djembe Bag **PBJCXL** 14" Djembe Bag **PBJCXXL** Bongo Bag **PSCBB** 12.5" Conga Bag **PSC125CG** 11.75" Conga Bag **PSC117CG** 11" Conga Bag **PSC110CG** 14" Djembe Bag **PSC140DJ** 12.5" Djembe Bag **PSC125DJ**

HOLDER & ACCESSORIES



Angled Post Adapter **PPS37** Lug Mount Accessory Holder **PPS40** Universal Guiro Holder **PGH20** Foot Pedal Bracket **PPS20** Cowbell Stacker **PCS10** Stix-Free **PPS10 & PPS11** Percussion Toy Box (Accessories Not Included) **PTYB1212**

COWBELL HOLDERS



CA130

75H

75X

PPS81

PPS82

BAGS & HOLDERS



PTT1524MPT
(Top Only)

Tech Tray (8.5" x 11")
PTT8511

Trap Table Single
Braced (18" x 24")
PTT1824

Trap Table Double
Braced (18" x 24")
PTT1824W

Aluminum Trap
Table (15" x 24") w/ Stand
PTT1524MPW

Trap Table
(12" x 12")
PTT1212

3/8" Straight Post
PTR1824RC1

3/8" Angled Post
PTR1824RC2

Post Attachment
PTR1824RC6

Trap Table Single
Post Adapter
PTR1824RC3

(FOR PTT1824, PTT1212)

Box Cajon Case
13" x 14" x 20"
PSC1213CJ

Travel
Conga Case
PSC1175TC

REPLACEMENT PARTS

Pearl offers a tremendous number of parts for our drums and hardware. The parts represented on these pages are some of the most commonly requested items.

For a more complete parts selection, please see our spare parts catalogs located under the Support tab at www.pearldrums.com

MASKING COVERS & MOUNTING BRACKET

The GK90 and BBC1 cover the holes of BT3 and BB3 brackets that have been removed.



- BBC1** for BB3, w/Casket, Screws and Nuts
- GK90** for BT3, inside/outside plates w/Bolts
- BT3** Tom Tom Bracket

BASS DRUM HOOP PROTECTORS



- HPP2** Metal Hoop Protector for Wood BD Hoops
- NP01** Hoop Protector for Metal BD Hoops
- NP347/2** Non-Slip Hoop Protector for Wood BD Hoops (pair)

P2050 SERIES CAMS



- P2050 SERIES CAMS**
- CAMPL** Eliminator Purple Cam, Aggressive Action
 - CAMYL** Eliminator Yellow Cam, Inverse Action
 - CAMTBK** Eliminator Translucent Black Cam, Linear Action
 - CAMTWT** Eliminator Translucent White Cam, Oversized Linear Action
 - CAMTBL** Eliminator Translucent Blue Cam, Progressive Action
 - CAMTRD** Eliminator Translucent Red Cam, Radical Action

FLOOR TOM LEGS & BRACKETS



- FTL07C/3** Floor Tom Legs (3 Legs)
- LG40L/3** Long Floor Tom Legs (3 Legs)
- LB40** Leg Bracket for Masters Series

HI-HAT CLUTCHES & PARTS

RAPID LOCK HI-HAT CLUTCHES
Hi-Hat set-up and tear-down is a breeze with Rapid-Lock's Patented* two-point quick release locking system. *U.S. Patent #9355625

- HCL205DQR** Rapid Lock Quick Release Hi-Hat Drop Clutch w/ Locking Nut
- HCL205QR** Rapid Lock Quick Release Super Grip Hi-Hat Clutch w/ Locking Nut
- HCL105QR** Rapid Lock Quick Release Hi-Hat Clutch w/ Locking Nut
- HCL79** Hi-Hat Clutch Complete
- HHC90** Plastic Cup w/ Tilter



CHAINS & BELTS



- CCA5** Chain Assy Complete for Eliminator Pedals
- BCA250** Belt Assy Complete for P2050 Eliminator Pedals

SPRING



- SP64F** Spring for P930/P932

BEATERS & BEATER WEIGHTS



- DB100** Duo-Beater Felt/Plastic
- B250QB** Control Core Quad Beater
- BEATER WEIGHTS**
- BW100** Beater Weight, 3 Weights in One (U.S. Patent #7122730)

MASTERCAST HOOPS

MasterCast are the finest die cast hoops available and feature the perfect blend of thickness and mass to improve the depth, clarity, and focus of toms and snare drums.



Model #	Diameter	# of Tension
DC0805	8"	5
DC1006	10"	6
DC1206	12"	6
DC1306	13"	6
DC1408	14"	8
DC1408S	14"	8 Snare Side
DC1410	14"	10
DC1410S	14"	10 Snare Side
DC1410SG	14"	10 Snare Side w/Guard
DC1508	15"	8
DC1608	16"	8
DC1808	18"	8

SuperHoop II & FATTONE HOOPS

SuperHoop II hoops are precision formed from heavy-duty 2.3mm steel, triple-flanged and engraved with the SuperHoop II logo. FatTone hoops are low mass 1.6mm hoops with hemmed and welded edges for strength and rigidity.

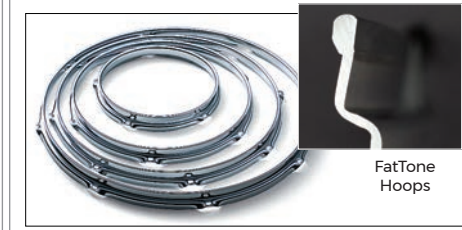

Super Hoop Model #	FatTone Hoop Model #	Diameter	# of Tension
SH0604	NA	6"	4
SH0805	FH0805	8"	5
SH1006	FH1006	10"	6
SH1006S	NA	10"	6 Snare Side
SH1206	FH1206	12"	6
SH1208	NA	12"	8
SH1208S	NA	12"	8 Snare Side
SH1306	FH1306	13"	6
SH1308	FH1308	13"	8
SH1308S	FH1308S	13"	8 Snare Side
SH1408	FH1408	14"	8
SH1408S	NA	14"	8
SH1410B	FH1410	14"	10
SH1410S	FH1410S	14"	10 Snare Side
SH1410SG	NA	14"	10 Snare Side w/Guard
SH1508	FH1508	15"	8
SH1510S	NA	15"	10
SH1510B	NA	15"	10
SH1608	FH1608	16"	8
SH1808	FH1808	18"	8

STEEL HOOPS

Steel Hoop Model #	Diameter	# of Tension
RH0804	8"	4
RH1006	10"	6
RH1206	12"	6
RH1306	13"	6
RH1408	14"	8
RH1408S	14"	8 Snare side
RH1608	16"	8
RH1808	18"	8



BASS DRUM PEDAL TRAINING PAD

BD10
The BD10 bass pad is perfect for practicing at home or on the road. The wide pad accommodates double pedals and is specially formulated for extremely low noise and a realistic feel. The universal-fit "hoop" accepts all brands of pedals and adjusts to compensate for different floor surfaces. The BD10 folds for compact transport.



QUICK RELEASE WINGLOC



- WL230** Quick Release WingLoc
- WL230A** Quick Release WingLoc Complete

SEAT CUPS AND FELTS



- RC20** Reversible Seat Cup, w/ O-Ring
- PL01** Cymbal Seat Cup
- FLW001/2** Cymbal Felt Washer (2 Pieces)
- FLW003** Hi-Hat Cup Felt Washer

STOP LOCK



- ZD081A** Stop Lock Complete

DRUM KEYS



- KGT100** Cyro Tune Key w/ Quick Release
- K030** Hi-Tension Tuning Key
- K080** Tuning Key
- K180** Spin-Tight Key

AIR SUSPENSION FEET



- R40/3** Air Suspension Rubber Feet (3 Each)
- R5/3** Rubber Tip



MASTERS MAPLE GUM SHOWN WITH MASTERCRAFT HOOPS



MASTERS MAPLE COMPLETE SHOWN WITH SuperHoop II HOOPS

LUGS

- CL05** Lug for 3" Piccolo Snare
- CL50** Lug for 5" Deep Snare
- CL55** Lug for 5.5" Deep Snare
- CL65** Lug for 6.5" Deep Snare
- CL100** Lug for 7" Deep Snare



REPLACEMENT PARTS

Pearl offers a tremendous number of parts for our drums and hardware. The parts represented on these pages are some of the most commonly requested items.

For a more complete parts selection, please see our spare parts catalogs located under the Support tab at www.pearldrums.com

OPTI-LOC

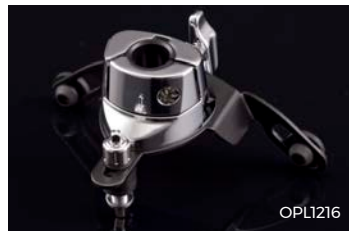

OPL1216

Opti-Loc suspension tom holders provide exceptional stability while greatly improving resonance and sustain. (For EXX / EXL Export / DMP)

- OPL0608/C** Opti-Loc for EXX and DMP 6"-8" Diameter
- OPL1216/C** Opti-Loc for EXX and DMP 12"-16" Diameter

JUNGLE GIG



JG16

JG16 - Pearl's Jungle Gig allows the conversion of a 16" Floor Tom to a Bass drum.

OPTIMOUNT

Our OptiMount Suspension System attaches to the tom's tension rods and floats on rubber cushions, providing the ultimate in stability while allowing the drum to resonate fully without restriction. With OptiMount, the mounting hardware is completely removed from the drum shell, providing a drastic improvement in resonance and sustain.



OPTA0708 OPTA0910 OPTA1112



OPT0708 OPT0910 OPT1112



OPT1314 OPT1516

- OPTA0708/C** for drums 7"-8" deep, 6"-16" diameter, Light Weight Aluminum
- OPTA0910/C** for drums 9"-10" deep, 6"-16" diameter, Light Weight Aluminum
- OPTA1112/C** for drums 11"-12" deep, 6"-16" diameter, Light Weight Aluminum
- OPTA1314/C** for drums 13"-14" deep, 6"-16" diameter, Light Weight Aluminum
- OPTA1516/C** for drums 15"-16" deep, 6"-16" diameter, Light Weight Aluminum

- OPT0708** for drums 7"-8" deep, 8"-16" diameter, UltraGrip Wingnut
- OPT0910** for drums 9"-10" deep, 8"-16" diameter, UltraGrip Wingnut
- OPT1112** for drums 11"-12" deep, 8"-16" diameter, UltraGrip Wingnut
- OPT1314** for drums 13"-14" deep, 8"-16" diameter, UltraGrip Wingnut
- OPT1516** for drums 15"-16" deep, 8"-16" diameter, UltraGrip Wingnut

MUFFLERS

External clamp-on muffler for snare drums and toms. By adjusting the pressure and position of the felt pad, excessive overtones can be precisely controlled or eliminated.



OM1

- OM1** Clamp-on Muffer, Snare Drum & Toms

MUFFLE HEADS

Model #	Size	Model #	Size
MFH08	8"	MFH14	14"
MFH10	10"	MFH16	16"
MFH12	12"	MFH20B	20"
MFH13	13"	MFH22B	22"

BASS DRUM MUFFLER



BDMF

BDMM

- BDMF** Bass Drum Muffer (Full Size)
- BDMM** Bass Drum Muffer (Mini Size)

STRAINERS



SR017

- SR014N** Standard Snare Strainer
- SR017** Snare Strainer Complete
- SR018** Snare Strainer Complete

TENSION ROD LOCKNUTS

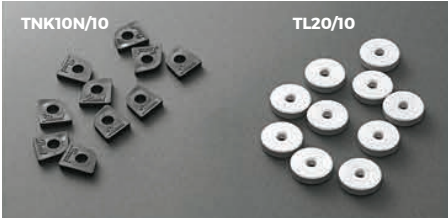

- TNK10N/10** Tension Keeper (10/pkg)
- TL20/10** Tension Rod Lock Nuts (10/pkg)

TENSION ROD WASHERS



- NLW12B/12** Nylon Washers (12) Black
- MTW12/12** Metal Washers (12)



ULTRA-SOUND SNARES

Pearl's Ultra-Sound snares feature patented Graduated Tension wires for extended dynamic range from ultra soft to ultra loud. Ultra-thin, low mass end plates assure ultra quick response. The end plates feature three mounting options: tunnels or holes for cord mounting and slots for straps. *U.S. Patent #7202405*

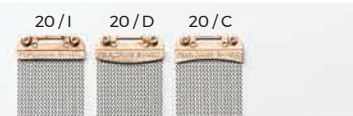

- SN1320C** 20 strands for 13", C-type, w/ straps & cords
- SN1320D** 20 strands for 13", D-type, w/ straps & cords
- SN1320I** 20 strands for 13", I-type, w/ straps & cords
- SN1420C** 20 strands for 14", C-type, w/ straps & cords
- SN1420D** 20 strands for 14", D-type, w/ straps & cords
- SN1420I** 20 strands for 14", I-type, w/ straps & cords



- SN1442C** 42 strands for 14", C-type, w/ straps & cords
- SN1442D** 42 strands for 14", D-type, w/ straps & cords
- SN1442I** 42 strands for 14", I-type, w/ straps & cords

REPLACEMENT SNARES

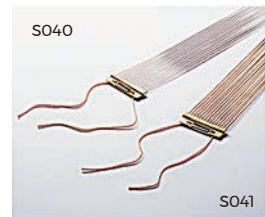

- S022N** 20 Strand for 14" w/ Cords
- S022NU** 20 Strand for 14" w/ Cords, Uncoated
- S022** 20 Strand for 14" w/ Straps
- S025** 20 Strand for 14" long, w/ Straps
- S029N** 20 Strand for 13" w/ Cords
- S030N** 24 Strand for 14" w/ Cords
- S031N** 20 Strand for 12" w/ Cords
- S032N** 12 Strand for 10" w/ Cords
- S033N** 12 Strand for 12" w/ Cords
- S040** 15 Strand for 14" w/ Cords, Steel Cable, Thinner Gauge
- S041** 15 Strand for 14" w/ Cords, Bronze Cable, Thicker Gauge
- SPS18/6** Plastic Strap (6/pkg)
- SNC500R/4** Snare Cord (4/pkg)

SPIN-TIGHT™ TENSION RODS

Specially-designed stainless steel tension rods that lock to maintain tension settings. Starter pack includes 4 Spin-Tight Tension rods with K180 Drum Key.



- K180**
- SPT5047** W7/32 x 47mm (1)
- SPT4SPK** W7/32 x 47mm (4) w/ K180 Drum Key
- SPT6PK** W7/32 x 47mm (6)

STAINLESS STEEL TENSION RODS

Pearl's Stainless Steel Tension Rods are machined, not forged, from a single piece of stainless steel to the most exacting tolerances in the industry. They feature super-smooth, precise tensioning, with absolutely no play. Each non-plated stainless steel tension rod is matched with a precision-machined brass swivel nut for ultra-precise performance.

- SST5028/6** W7/32 x 28mm (6)
- SST5035/6** W7/32 x 35mm (6)
- SST5038/6** W7/32 x 38mm (6)
- SST5042/6** W7/32 x 42mm (6)
- SST5047/6** W7/32 x 47mm (6)
- SST5052/6** W7/32 x 52mm (6)

TENSION RODS

- T055/6** W7/32 x 28mm (6) for 3" Deep Snare
- T060/6** W7/32 x 35mm (6) for Free Floaters before 2002
- T061/6** W7/32 x 42mm (6)
- T061L/6** W7/32 x 47mm (6) for 6.5" Deep Snare
- T062/6** W7/32 x 52mm (6) for 5.5" Deep Snare
- T065** M6 x 90mm (Bass Drum)
- T066** M6 x 115mm (Bass Drum)
- TR5052** W7/32 x 52mm (DMP, EXL, EXX, MDT Snare)
- TR5047** W7/32 x 47mm (DMP, EXL, EXX, MDT Toms)
- TR5100** W7/32 x 100mm (Bass Drum)



T055/6

T060/6

T061/6

T061L/6

T062/6

T065

T066

PEARL ARTISTS

VIEW ALL THE PEARL ARTISTS AT: WWW.PEARLDRUM.COM/ARTIST



AARON SMITH Independent
ADRIAN BENT Drake/Daniel Caesar
AREJAY HALE Halestorm
ALVIN FORD Ed O'Brien/Trombone Shorty
AUSTIN BURCHAM ABBDRUMS



BAARD KOLSTAD Leprous
BARRY KERCH Shinedown
BEN GORDON Parkway Drive
BEN JOHNSTON Biffy Clyro
BILLY HART Jazz Legend



BRANDON PERTZBORN Marilyn Manson
BRANDON COMBS Leon Bridges
BRIAN FRASIER-MOORE Justin Timberlake
BRUNO VALVERDE Angra
CALVIN RODGERS Independent



CASEY COOPER @COOP3RDRUMM3R
CHAD SEXTON 311
CHARLIE ENGEN Five Finger Death Punch
DAN PRESLAND Neobliviscaris
DANIEL ERLANDSSON Arch Enemy



DENA TAURIELLO Broadway / Independent
DENNIS CHAMBERS Drumming Legend
DESMOND DAVIS Hunter Hayes
EDDIE BAYERS Nashville Legend
ELISE TROUW Independent



ERIC SINGER KISS
FLO MOUNIER Cryptopsy
FREDO ORTIZ Cogol Bordello
GARY HUSBAND Independent
GENE HOGLAN Testament/Dethklok



GABE HELGUERA I Prevail
GEORGE KOLLIAS Nile
GREYSON NEKRUTMAN Independent
HARRY MIREE Lindsay Ell
HORACIO HERNANDEZ Latin Legend



HUBERT PAYNE Little Big Town
IAN PAICE Deep Purple
INFERNO Behemoth
JAMIE PERKINS The Pretty Reckless
JASON BITTNER Overkill



JASON BOWLD Bullet For My Valentine
JASON HARTLESS Ted Nugent / Studio
JEFF MARINO Darius Rucker
JEN LEDGER Skillet / Ledger
JERROD SULLIVAN The 4 Korners

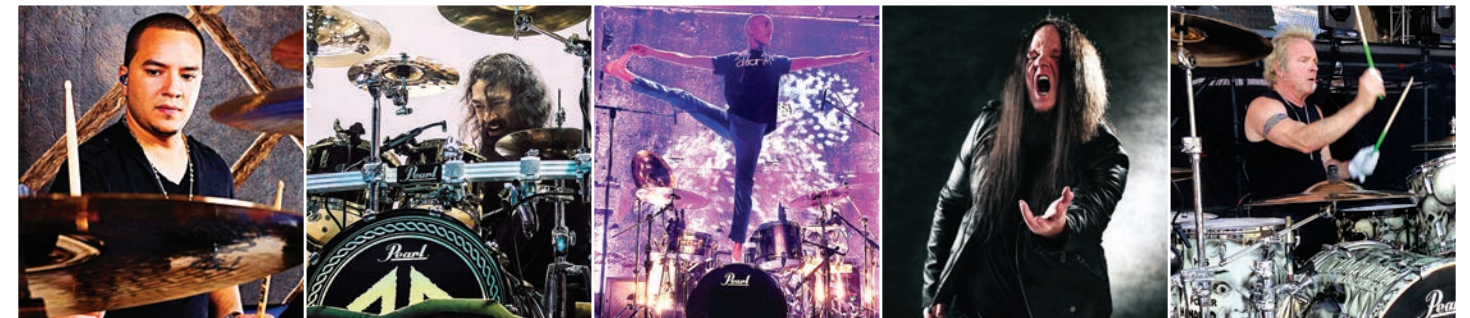

JESSIE CARABALLO Marc Anthony
JOCKE WALLGREN Amon Amarth
JOE TOMINO Matisyahu / Dub Trio
JOEY JORDISON Independent
JOEY KRAMER Aerosmith

PEARL ARTISTS

VIEW ALL THE PEARL ARTISTS AT: WWW.PEARLDRUM.COM/ARTIST



JOHN LONGSTRETH
Origin



JOHN WICKS
Fitz and The Tantrums



JON LARSEN
Volbeat



JONATHAN MOVER
Independent



JOSH BAKER
Mariah Carey



MORGAN ROSE
Sevendust



NATE MORTON
The Voice



OMAR HAKIM
Independent



PAUL KOEHLER
Silverstein



PETE WEBBER
Havok



JUAN "CARLITO" MENDOZA
Independent



KAI HAHTO
Nightwish



KEIO STROUD
Big & Rich



KENT SLUCHER
Luke Bryan



KENWOOD DENNARD
Independent



QUINTON "Q" ROBINSON
Independent



RAY LUZIER
Korn / KXM



RICKY LEWIS
The Weeknd



ROBBY AMEEN
Independent



RYAN MORAN
Slightly Stoopid



KIKO FREITAS
Independent



KRIS MYERS
Umprey's McGee



LENNY "THE OX" REECE
The Lesson GK



LESTER ESTELLE
Kelly Clarkson/Sessions



MARCUS FINNIE
Marcus Finnie Band



SAM LOEFFLER
Chevelle



SERGIO MELO
The Voice Brazil



SHANE GAALAAS
Cosmosquad



SHANNON FORREST
Toto / Sessions



TARON LOCKETT
Cory Henry And The Funk Apostles



MARVIN "SMITTY" SMITH
Independent



MATT ABTS
Gov't Mule



MATT HALPERN
Periphery



MATT MCGUIRE
The Chainsmokers



MELVIN BALDWIN
Justin Bieber



TAVARIUS JOHNSON
Lalah Hathaway



TERENCE HIGGINS
Warren Haynes / Ani DiFranco



TODD SUCHERMAN
Styx



TOM HURST
Tracy Lawrence



TONY PALERMO
Papa Roach



MICHAEL CARTELLONE
Lynyrd Skynyrd



MIGUEL LAMAS
Independent



MIKE MANGINI
Dream Theater



MIKE MILEY
Rival Sons



MIKE WENGTREN
Disturbed



TRACY BROUSSARD
Blake Shelton



TROY WRIGHT
Independent



TRAVIS ORBIN
Darkest Hour



WILL HUNT
Evanescence



WILL KENNEDY
Yellowjackets / Jazz Legend

COLOR & CONFIGURATION CHART

MASTERS MAPLE RESERVE A CLASSIC FORMULA FOR SONIC GREATNESS.

PAGES 24 - 25



Masters Maple Reserve is available in all 35 Music City Custom special order finishes - see Page 23.
Also available in 28 Special Order Lacquer finishes - see Back Cover.

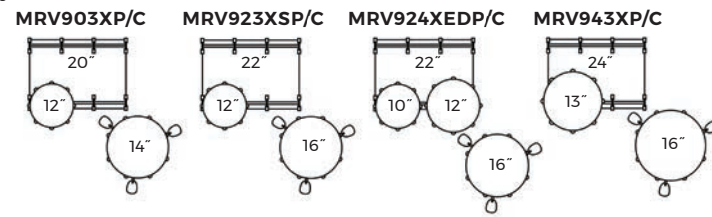

MASTERS MAPLE GUM THE EVOLUTION OF PREMIUM STUDIO TONE.

PAGES 26 - 27



Masters Maple Gum is available in all 35 Music City Custom special order finishes - see Page 23.
Also available in 28 Special Order Lacquer finishes - see Back Cover.
Added components in #186 can be special ordered.

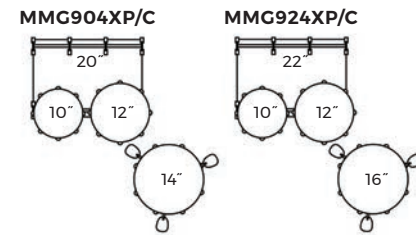

MASTERS MAPLE COMPLETE AN ALL MAPLE DRUM SHELL FIT FOR THE MASTERS LEGACY.

PAGES 28 - 29

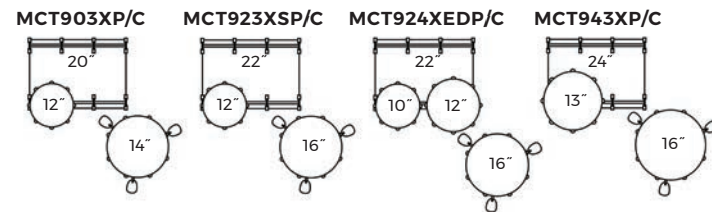

SESSION STUDIO SELECT A COMPLETELY NEW TAKE ON THE FULL SPECTRUM SOUND.

PAGES 30 - 31



HIGH GLOSS LACQUER
PREMIUM DELMAR WRAP

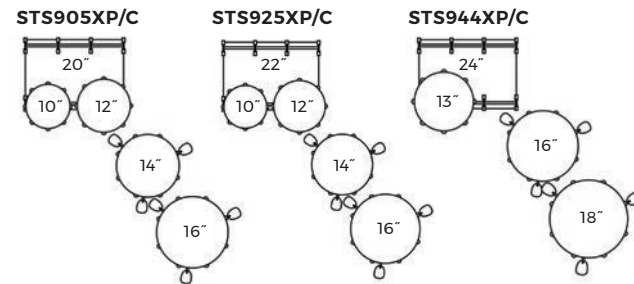

CRYSTAL BEAT THE ORIGINAL SEAMLESS ACRYLIC DRUM SHELL.

PAGES 32 - 33



Individual components also available. For sizes, visit www.pearldrums.com

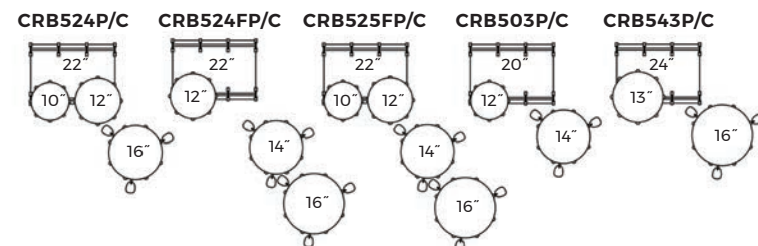

COLOR & CONFIGURATION CHART

DECADE MAPLE A DRUM KIT 10 YEARS IN THE MAKING.

PAGES 34 - 35

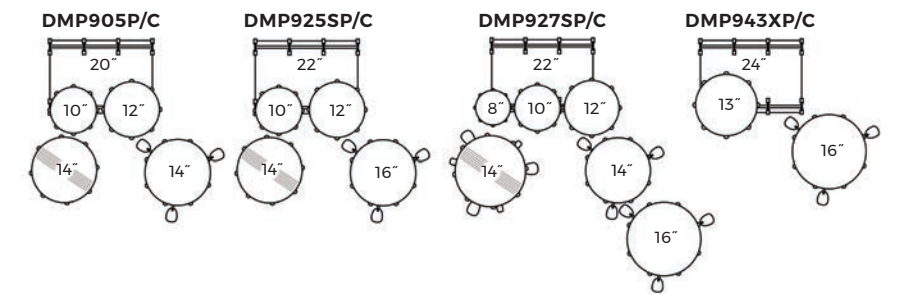

EXPORT LACQUER THE LEGENDS OF TOMORROW, PLAY EXPORT TODAY.

PAGE 36

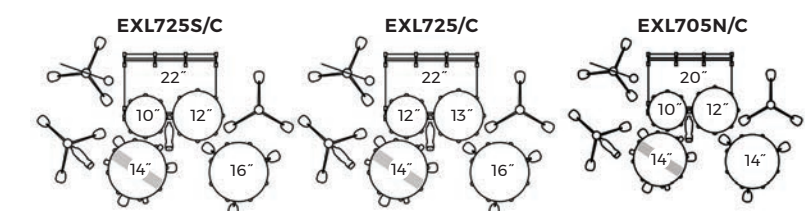

INCLUDES HWP830 HARDWARE PACK

EXPORT THE BEST SELLING DRUM SET OF ALL TIME.

PAGE 37

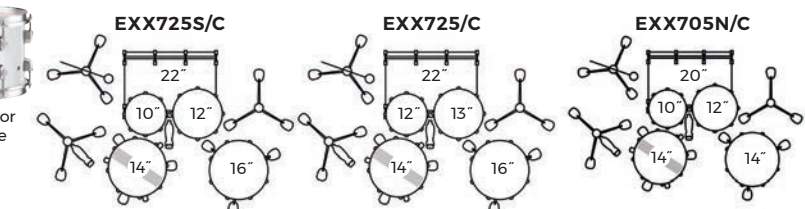

INCLUDES HWP830 HARDWARE PACK

MIDTOWN BIG GIG, SMALL RIG, HUGE SOUND.

PAGE 38

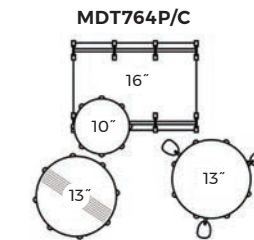

ROADSHOW JR.

PAGE 39

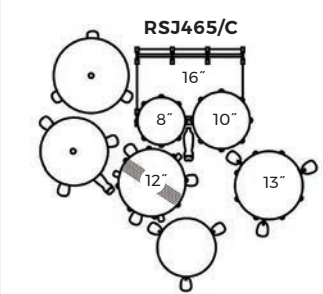

Complete with Hardware, Cymbals, and Throne for Drummers under 8.

ROADSHOW IT'S YOUR TIME TO PLAY, START THE RIGHT WAY.

PAGE 39

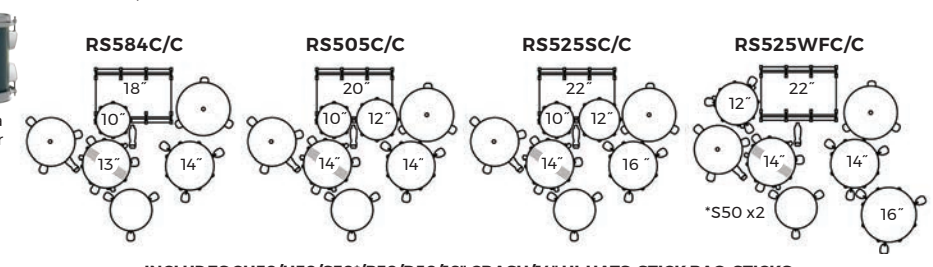

INCLUDES CH50/H50/S50/P50/D50/16" CRASH/14" HI-HATS, STICK BAG, STICKS

Pearl® SPECIAL ORDER LACQUER FINISHES

PAGES 14 - 17

CONFIGURATIONS:

REFERENCE
SONICALLY SELECT DRUM PERFORMANCE.

REFERENCE PURE
UNRESTRICTED TONAL RESPONSE.

RF903XP/C
RFP903XP/C

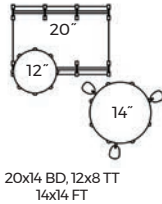

RF924XEDP/C
RFP924XEDP/C

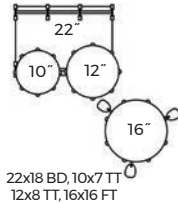

RF924XSP/C
RFP924XSP/C

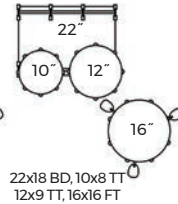

RF923XSP/C
RFP923XSP/C

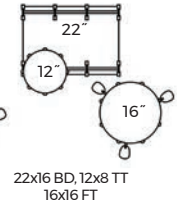

RF943XP/C
RFP943XP/C

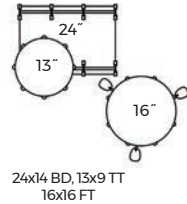

SPECIAL ORDER LACQUER FINISHES

AVAILABLE IN REFERENCE, REFERENCE PURE, MASTERS MAPLE RESERVE, AND MASTERS MAPLE GUM SERIES



#100 Wine Red



#102 Natural Maple



#103 Piano Black



#109 Arctic White



#142 Rootbeer Fade



#143 Twilight Fade



#155 Scarlet Fade



#197 Rhythm Blue



#302 Inca Gold Burst



#329 Burnished
Bronze Sparkle



#330 Ivory Pearl



#334 Red Metallic



#335 Black Cherry



#342 Vintage
Tobacco Burst



#345 Satin Auburn



#355 Antique
Walnut



#376 Ultra
Blue Fade



#377 Scarlet
Sparkle Burst



#393 Purple Craze II



#830 Autumn
Fire Sparkle



#831 Matte
Olive Burst



#832 Sapphire
Blue Sparkle



#833 Emerald
Sparkle



#834 Glacier
Blue Sparkle



#835 Aged
Honeyburst



#839 Red Burst
Triband



#842 Light
Amber



#844 Satin
Rose Gold



THE BEST WARRANTY IN THE INDUSTRY! *

COMMITTED TO THE HIGHEST LEVEL OF CUSTOMER SATISFACTION.

The Pearl Lifetime Warranty is a statement of confidence to our customers to the reliability of Pearl products. Pearl drums, stands and hardware are designed and manufactured to the highest standards in quality, style, appearance and playing performance. This lifetime warranty reflects a tradition of excellence and a commitment to superior engineering and craftsmanship dedicated to you, the drummer. The Pearl lifetime warranty is our pledge to you that we will proudly stand behind our product for as long as you own it. *Buy it once, play it for life.*

- Drum Set/Concert wood and metal shells for the Lifetime of the Original Owner.
- Foot pedals, hi-hat stands, cymbals stands, boom cymbal stands, snare drum stands, throne bases, floor-standing tom stands, floor-standing cymbal/tom stands, concert stands, racks and rack accessories, cymbal holders and multi-clamps for the Lifetime of the Original Owner. Some exceptions apply.
- Drum Set claws, tension rods, swivel nuts, spurs, tom brackets, tom holders, strainers, and nuts and bolts for the Lifetime of the Original Owner.
- Rotationally molded cases for the Lifetime of the Original Owner.
- The Lifetime Warranty applies to the aforementioned Pearl products purchased from June 15, 2009.
- * This Lifetime Warranty is valid only in the United States and excludes the Crystal Beat and Roadshow Series.

PEARL CORPORATION Corporate Headquarters
549 Metroplex Dr., P.O. Box 111240 Nashville, TN 37211-3140 | (615) 833-4477 FAX (615) 833-6242

WWW.PEARLDRUM.COM



pearldrumsfan



PearlDrumCorp



pearl_drums



PearlDrumCorp



pearldrumsforum.com